

LITERATURE REPORT OF ELASTOMER SEALING MATERIALS AND CEMENT SYSTEMS

SUBMISSION DATE:

November 9, 2017

BSEE PROJECT NO.:

E17PC00005

PROJECT TITLE:

Studying “fitness for service” of the sealing assemblies and cement system in shallow well designs by conducting scaled laboratory testing, leakage modelling and risk assessment

AUTHORS:

George Kwatia, Graduate Research Assistant
Chinedum Ezeakacha, Graduate Research Assistant
Saeed Salehi, PhD, Principal Investigator

By

University of Oklahoma

Contents

Executive Summary	1
1. Elastomers	7
1.1 Types and Composition of Elastomers	10
1.2 Elastomers in Oil and Gas Industry	14
1.3 Properties and Testing of Elastomers	17
1.4 Summary	26
2 Shallow Flows, Gas Migration in Shallow Wells, Cement Design, Integrity and Evaluation	28
2.1 Gas Migration	29
2.2 Shallow Gas Loss of Well Control (LOWC)	33
2.2.1 Loss of Well Control Incidents While Tripping	35
2.3 Wellbore Integrity and Cement Design	39
2.3.1 Mechanisms for Failure of Wellbore Integrity	40
2.3.2 Cement Design and Integrity	41
2.3.3 Key Factors Impacting Cement Design	46
2.4 Cement Integrity Evaluation Logs	51
2.5 Pressure Integrity Tests	55
2.5.1 Review of Pressure Integrity Tests	56
2.6 Summary	60
Abbreviations	61
Appendix	63
References	68

Definitions

For the understanding of this document the following terms and definitions apply. In addition to the few listed, other definitions and abbreviations can be found on oilfield glossaries and oil and gas websites. All abbreviations and definitions are in accordance with their standard use in the oil and gas industry.

Aging

Elastomer aging is logically a chemical change ultimately manifesting itself in a physical shift of mechanical properties.

Ambient pressure

Pressure external to the wellhead. A surface wellhead would read 0 psig while the subsea wellhead would read the hydrostatic pressure of the seawater.

Annular flow

The flow of formation liquid and/or gas from the formation into a space in the annulus within the well. Annular flow may migrate via various flow paths inside the annulus to other points – shallower or deeper depths.

Annulus and Annuli

The space or spaces between the borehole and tubulars or between tubulars, where fluids (gas or liquid) can flow. A well has probability of creating more annuli depending on the use of multiple casing strings and liner pipe strings.

Barrier (barrier element)

A component or practice that contributes to the total system reliability by preventing the flow of formation fluids if installed properly.

Blowout Preventer (BOP)

A blowout preventer (BOP) is a device attached to the casing head that allows the well to be sealed to confine the well fluids in the wellbore in cases of kicks and blowouts.

Borehole

A narrow shaft bored in the ground (vertical or horizontal) for the extraction of water, oil or gas.

Cement bond log (CBL)

Cement bond log is the use of varied amplitudes received from an acoustic signal travelling down the casing wall to determine the quality of a cement bond on the exterior of the casing.

Crosslinking

Crosslinking is chemically joining two or more molecules or adjacent chains of a complex molecule (polymer) by a covalent bond.

Diverter

A diverter is a device connected to the top of the wellhead or marine riser, directing flow away from the rig.

Extended leak off test (XLOT)

Extended leak off test (XLOT) is a type of leak off test needed to understand wellbore conditions and used to accurately estimate the fracture gradient of the formation. It requires a significant fracturing of the formation.

Formation fluids

Fluids present within the pores, fractures, faults, vugs, caverns, or any other spaces of the formations. They include various types of hydrocarbons, fresh or saline water, carbon dioxide, and hydrogen sulphide. The physical states of formation fluids can either be liquid or gas.

Formation integrity test (FIT)

Formation Integrity Test (FIT) is used to evaluate cement and shoe integrity by pressurizing the well to a predetermined value based on what formation pressures would be reached during drilling the next stage of the wellbore.

Fracture gradient (FG)

The fracture gradient is a factor that when multiplied by the true vertical depth, calculates the fracture initiation pressure of the formation.

Leak off test (LOT)

Leak off test (LOT) is a pressure integrity test in which the pressure is increased until there is a leak of drilling fluid due to fracture initiation.

Liner

A liner is a casing string that does not extend to the top of the well or to the wellhead. Liners are anchored or suspended from inside the previous casing string using a liner hanger. The liner can be fitted with special components so that it can be connected or tied back to the surface at a later time.

Liner hanger

A device used to attach or hang a liner from the internal wall of a previously set casing string. Conventional liner hangers are “hung” (connected to the last casing) by setting slips that grip against the inner wall of the previously set casing string. Expandable liner hangers are hung by external expansion of the hanger against the inner wall of the previously set casing string.

Loss of well control (LWC)

A loss of well control incident is an uncontrolled flow of subterranean formation fluids such as gas, oil, water, etc. and/or well fluids into the environment or into a separate underground formation, in which case it is called an underground blowout.

Non-aqueous fluid (NAF)

Non-aqueous fluid is a non-aqueous drilling fluid or well circulating fluid. Common NAF systems are diesel, mineral oil, or synthetic fluid based invert emulsions, or other non-water based fluids.

Packers and seal rings

Mechanical barrier devices with flexible, elastomeric sealing elements that can be run into a well on casing or liners for application as:

- a) annular element installed between an inner and outer pipe or between a casing and open hole formation to seal the annulus,
- b) annular seal rings installed on the inner pipe string to seal the micro-annulus and voids formed between the cement sheath and the inner pipe string.

Pore pressure (PP)

Pore pressure is the pressure of formation fluids inside the pores of the formation.

Rate of penetration (ROP)

Rate of penetration is a term for drilling rate expressed in ft/hour or m/hour.

Rapid gas decompression (RGD)

It is a phenomenon where high pressure gas molecules migrate into an elastomer at a compressed state. When the pressure surrounding the elastomer is suddenly released, the compressed gas inside the elastomer tries to expand and exerts the elastomer in an explosive decompression. Elastomers can experience blistering or cracking under such conditions since the expanded gases overcome the strength of the material.

Riser

The extension of a wellbore from from the subsea BOP stack to the drilling vessel. The riser provides for fluid returns to the drilling vessel, supports the chock, kill, and control lines. It also guides tools into the well, and serves as a running string for the BOP stack.

Static gel strength (SGS)

The yield stress of fluids at rest; usually expressed as lbf/100 ft².

Surge

Surge is a transient sudden increase or decrease in pressure in a pipeline, if uncontrolled can lead to the rupturing of the pipeline.

Swabbing

Swabbing in a well is reducing the pressure in the wellbore by moving the pipe. This can lead to the influx and migration of formation fluids to surface.

Variable density log (VDL)

Variable-density log serves as an adjunct to cement bond logs to help give insight to the interpretation of a cement bond log. It is a continuous-depth time display of full-waveform amplitude - received from a sonic or ultrasonic tool - presented as shades of grey.

Vulcanization

Vulcanization is the addition of curative materials, accelerators or sulphur to natural rubber or polymers to make them more durable materials.

Waiting on cement (WOC)

Waiting on cement, normally expressed in hours, is the period after the cement has been placed until the time subsequent drilling or completions operations can resume.

Well integrity

A quality or condition of a well in being structurally sound with competent pressure seals by the application of technical, operational and organizational solutions that reduce the risk of uncontrolled release of formation fluids throughout the well life cycle.

Executive Summary

This report presents accomplishments of first task (Literature review and theoretical study on shallow-section sealing and cement (SSC) systems) under BSEE project# E17PC00005. The primary objective of this report is to review literature studies related to: i) elastomers; and ii) shallow gas cement design and integrity, well control implications and evaluation tools and methods. In the first section of this report, a review of elastomers, types, compositions and typical elastomer applications in oil and gas industry is presented. The second section of this report, is a review of shallow gas kick conditions, gas migration, cement evaluation logs and pressure integrity tests.

Review of literature for elastomers indicates that the behavior of these materials depends very strongly on their environment and impacted by different factors such as temperature, pressure, chemical exposure and aging period. Performance of these materials under downhole corrosive gas conditions is currently unknown and this may pose risks to well integrity and to the environment in case of severe loss of well control incidents. It is unclear if these materials can be “fit for service” under downhole conditions due to lack of research and experimental data to show their fitness. Additional steps are required to ensure that elastomer barriers are adequately designed and tested for downhole conditions. One challenge is to know the exact formulation and type of elastomer used in downhole equipment since formulation and processing method of elastomers impact their properties. Current studies in the literature indicate deterioration of elastomer properties under H₂S, CO₂, and HCl conditions. Furthermore, temperature reported as a critical factor affecting elastomeric properties. An experimental study showed accelerated degradation of elastomer properties at high temperatures.

Successful casing and cementing programs are especially critical for the shallow or top-hole sections of a well. A review of the second section shows that many of shallow loss of well control incidents have occurred due to gas migration through cement column, faulty casing or equipment, and failure in different well design barriers. Gas migration is a complex phenomenon with causes related to the cementing process involving several factors. Decades of research into gas migration have provided industry with some solutions such as use of new additives, optimizing cement mix designs, and operational procedures; however, no single solution still exists to fit all downhole conditions. A recent report classifies different major causes for shallow zone kicks such as unexpected high well pressure, annular losses (swabbing), poor cement; and other unknown factors. Furthermore, current cement and well integrity evaluation tools and pressure tests are unable to provide reliable information on the “fitness” of each individual barrier in the hole.

1. Elastomers

Elastomers are materials that exhibit rapid and large reversible strain, in response to a stress. Elastomers are an important class of polymers that have randomly distributed chains, which are connected by cross links in their molecular structure (Visakh, 2013). Elastomers are made up of long chains of monomers (i.e. typically consist of more than 300,000 monomer units) that have strong cross-linking bond with their neighboring chains that pulls the elastomer back into the original shape when the deforming force is removed. A more technical definition is provided by ASTM, which states, “An elastomer is a polymeric material which at room temperature can be stretched at least twice its original length and upon immediate release of the stress will return quickly to its original length.”

Formulation and processing method of elastomers impact their properties. Generally, basic characteristics of elastomers are determined by the type of polymer used in manufacturing and the nature and level of crosslinking occurring during vulcanization process. In high molecular weight polymers, they form entanglements by molecular intertwining as shown in Figure 1a. In cross-linked elastomer, many of these entanglements are permanently locked (Figure 1b). Additionally, the response of elastomer materials to external forces are intermolecular, that is, “the externally applied forces are transmitted to the long chains through the linkage, and each chain acts like an individual spring in response to the external force” (Drobny, 2007).

Elastomers are arguably the most versatile of engineering materials as of today, and have multiple uses (Walker, 2011). Elastomers have diverse applications in nearly all disciplines of physical science and engineering. Mechanical engineers use elastomers for noise reduction and dampening, while electrical engineers use them for electrical and thermal insulation. In the oil and gas industry, elastomers are used as hydraulic seals, O-rings, packers, liner hangers and in many other downhole equipment. Elastomer seals are essential for zonal isolation in vertical and deviated wells. They are often used in liner hanger systems, and as packers which acts as a strong seal, preventing influx and channeling of hydrocarbon between the production casing and tubing (Davis, 2008 and Gavioli, 2012). The randomly distributed chains of elastomers prevent them from having a crystalline nature. In addition, the stiffness of rubber does not arise from bond stiffness, but from this disordering or entropic factor (Roylance, 2000).

Per Visakh et al. (2013) there are two major steps in elastomer processing. The first step involves the design of a mixing formulation for a specific end use. The second is the production process whereby rubber compounds are transformed into final products. In the rubber formulation, the raw material polymer can be softened mechanically by means of mastication, or chemically with the help of peptisers (peptization). Mastication is a mechanical method of breaking down the nervousness of rubber to reduce its viscosity for good dispersion of ingredients. Under these processing conditions, rubber chemicals, fillers,

and other additives can be added and mixed with the polymer to form the uncured rubber compound. Using a two-roll mill during distributive mixing, the rubber flows around the filler agglomerates. Therefore, penetrating the interstices between particles in the agglomerate, making it denser and immobile. Immobility tends to dampen the effective rubber content, while the incompressibility of the mixture allows a force of great magnitude to be applied to the mixture. The high force applied to the mixture, causes the agglomerates to fracture (dispersive mixing), and plasticizers are used to facilitate ease of filler incorporation. At the culmination of the mixing process, curatives are added to help cure the elastomer after which the mix is homogenized and sheeted out. The mixing procedure is usually carried out at a temperature of $77\pm 2^{\circ}\text{F}$, for optimum mixing conditions. To obtain a desired elastomer shape, an extruder is used to structure the rubber into the preferred shape. The extruder die is used in shaping the elastomer into the desired shape.

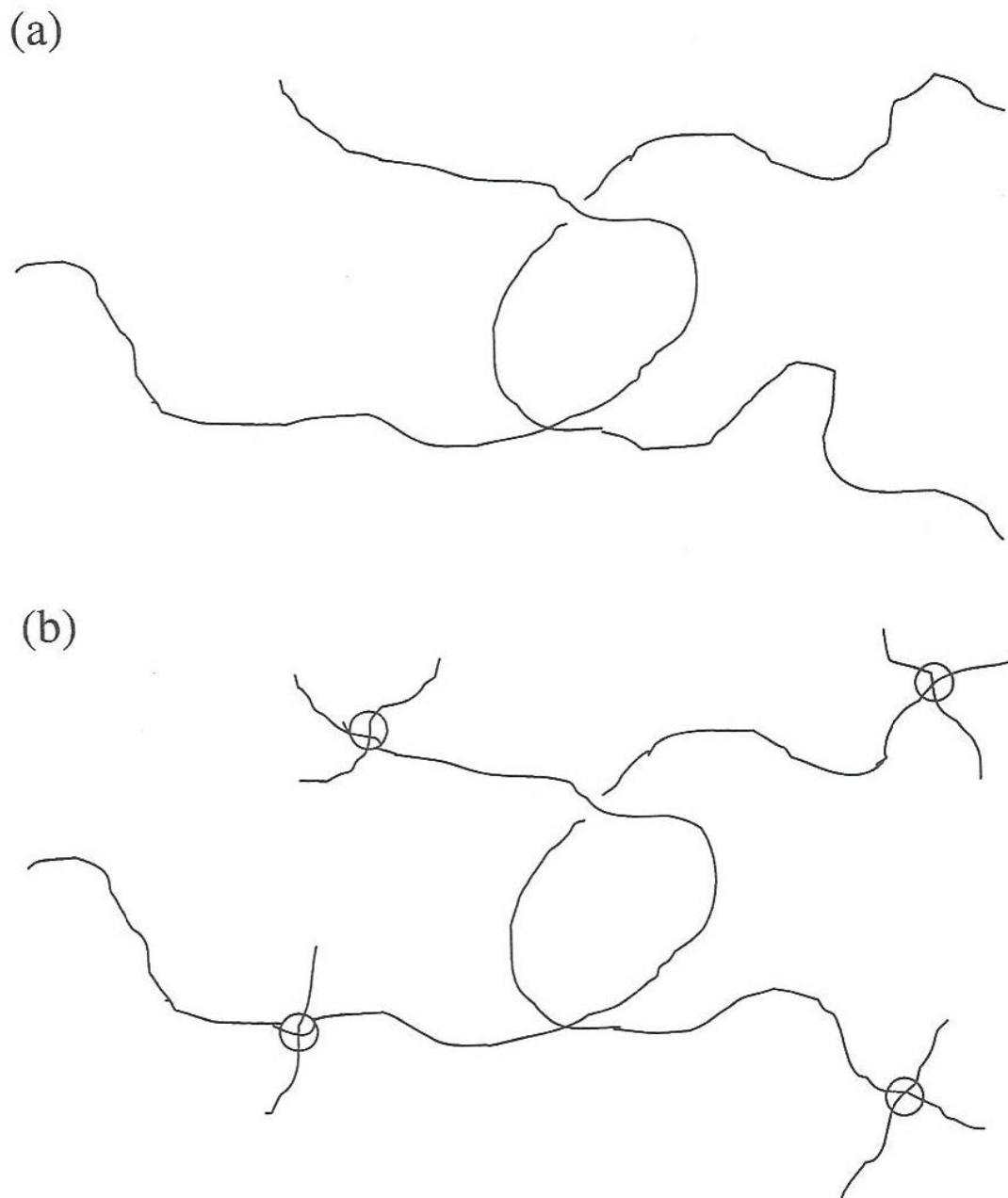

Figure 1. Molecular entanglement in high molecular weight polymer (a) Molecular entanglement in elastomer locked by cross linking (b) (from Drobný, 2007).

1.1 Types and Composition of Elastomers

Elastomers are often classified into two major categories, namely thermosets and thermoplastics. Thermosets are very common type of elastomers, which gain most of their strength after strong and permanent crosslinking (vulcanization) under elevated pressure and temperature. Thermoplastics undergo weaker crosslinking and behave like plastic materials; however, they exhibit common characteristics of elastomers such as good elasticity and flexibility. Most of elastomers used in oil field such as nitrile (NBR), hydrogenated nitrile (HNBR), fluorocarbon (FKM/Viton), perfluorocarbon (FFKM/Kalrez) and Tetrafluoroethylene propylene (FEPM/Aflas) are thermosets.

Other way to classify elastomers is group them into general purpose and special purpose elastomers. The general-purpose elastomers include: natural rubber, styrene-butadiene rubber (SBR), ethylene propylene diene monomer (EPDM), polychloroprene, and thermoplastic elastomers. Natural rubber (NR) is the most significant among general purpose elastomers. They are normally used after compounding with additives such as fillers, vulcanizing agents, and antioxidants. NR does not turn to abrade (wear), and has some features that makes it the most common type of elastomer. Some of these features include chemical resistance to acids, alcohols, and alkalis, electrical resistance, and shock absorption properties. NR has been extensively applied in the manufacturing of truck and aircraft tires, amongst others.

SBR is composed of styrene and butadiene. It exhibits a better resistance to abrasion, compared to natural rubber. EPDM, which is also a synthetic rubber like SBR, has a saturated polymer backbone structure that enables it to possess an outstanding resistance to heat, ozone, and weather changes. The non-polar nature of EPDM renders it a bad conductor of electricity and resistant to polar solvents. As such, this material is used in the manufacturing of steam hoses, roofing membranes, and electrical insulators. Polychloroprene, also known as chlorinated rubber, was first invented in 1930 by Arnold Collins (Britannica, 2009). They were formulated to be resistant to most inorganic acids, alkalis, salts, mineral oils, moisture, and fungus growth. The compound was also designed to have excellent flexibility, ozone resistance, as well as a resistance to weather change. Chlorinated rubber paints are commonly used in marine, waste water applications, central processing unit socket insulation, bearings and seals for construction application, and waterproof seat covers in the automotive industry.





Thermoplastic elastomers are also considered to be general purpose elastomers. They include styrenic block copolymers (SBCs) and polyolefin thermoplastic elastomers (TPOs) (Visakh et al., 2013). SBCs are the economic thermoplastic elastomer used to manufacture footwear, sealants, and some adhesives. TPOs are a co-continuous phase system made up of polyolefin semi-crystalline thermoplastic and amorphous elastomeric components. The polyolefin semi-crystalline thermoplastic contributes to the

strength of the elastomer, while the amorphous elastomeric components provide the flexibility of the elastomer (Killian, 2014). Table 1 shows some of the common general-purpose elastomers with their abbreviation and structures.

For the most part, general-purpose elastomers have proven to be useful in normal pressure and temperature conditions. However, advancement in technology, and the need for elastomers that can withstand harsh environmental and operational conditions led to the development of special purpose elastomers. Special purpose elastomers as the name implies, are elastomers that have specific applications in various fields. One of the common special purpose elastomer is Isobutylene-co-isoprene, popularly known as butyl rubber and a copolymer of both isoprene and isobutylene monomers. It possesses a low permeability feature, which makes it desirable in airtight rubbers, and it can clean up oil spills when used as Elastol. Elastol is a long-chain polymer capable of mixing properly with spilled oil to form a physical polymer. Acrylonitrile butadiene rubber (NBR), popularly known as nitrile rubber is an important type of special purpose elastomer. Acrylonitrile and butadiene are the two monomers that influences the properties of NBR. The acrylonitrile (ACN) content is used to categorize NBR into low (less than 30% ACN), medium (30 – 45% ACN), and high (more than 45% ACN). The CAN content can vary from one manufacturer to another. Per Eriks Seals and Plastics (2017) (Table A1 in appendix), the medium NBR is usually more applicable since low ACN improves flexibility at low temperature and high ACN content enhances the resistance to aromatic hydrocarbons. Generally, NBR elastomers have ultra-low gas permeability, enhanced ozone resistance, high temperature aging (40°F to 250°F), improved hardness, abrasion and tensile strength, as well as high resistance to aliphatic hydrocarbon fuels and oils. Figure 2 (a) shows the repeating chemical structure of NBR.

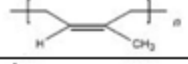
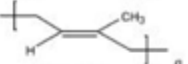
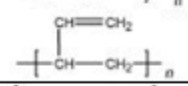
The saturated form of NBR is known as hydrogenated nitrile-butadiene rubber (HNBR) which is shown in Figure 2 (b). This material has the significant ability to resist heat (up to 320°F), maintain high physical strength, and retain its properties after long-term exposure to oil, chemicals, and heat. For these reasons, HNBR is widely used in oil and gas applications such as in blowout (BOP) preventers, Chevron seals, heat exchanger gaskets, oil field packers, paper mill rolls, and rotary shaft seals. Fluoroelastomers are another type of special purpose elastomers. They are fluorine containing polymers with saturated structure which is obtained by polymerizing fluorinated monomers such as vinylidene fluoride, hexafluoropropene, and tetrafluoroethylene (Schweitzer P.A., 2000). Per ASTM D1418 standard, 80% of fluoroelastomers are referred to as FKM. The repeating chemical structure of FKM is shown in Figure 3a. There are some other types of fluorinated elastomers, such as perfluoro-elastomers (FFKM) shown in Figure 3c and tetrafluoro ethylene/propylene rubber (FEPM) shown in Figure 3b.

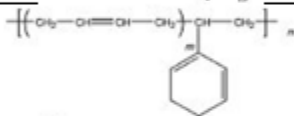
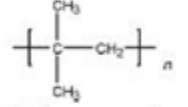
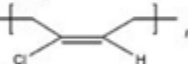
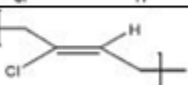
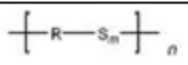
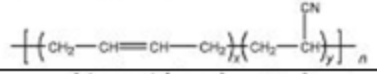
Table 1. Common general-purpose elastomers with structures (from Visakh et al., 2013).

Common name	Abbreviation	Structure of repeat unit
cis-1,4-polyisoprene	NR, caoutchouc	
trans-1,4-polyisoprene	Gutta percha	
1,2-polybutadiene	BR	
cis-1,4-polybutadiene		
trans-1,4-polybutadiene		
Butadiene styrene or styrene butadiene rubber	BS/SBR	
Butyl rubber	IIR	
cis-1,4-polychloroprene	CR	
trans-1,4-polychloroprene		
Polysulfide butadiene rubber	PSR	
Acrylonitrile butadiene rubber	NBR	
Ethylene propylene diene rubbers	EPDM	

Fluoroelastomers are chemically more stable, and have desirable resistance to gas penetration, radiation, oil and chemicals. In addition, polysulfide rubbers are also considered special purpose elastomers with relatively high resistance to petroleum solvents, organic solvents, ultraviolet rays, ozone and aromatic fuels. Table A1 in the appendix shows the detailed properties of several types of general purpose and special purpose elastomers. In this table, it is suggested that HNBRs often fill the gap between NBRs and FKM in many areas of application where resistance to heat and aggressive media are required simultaneously. They provide a lower cost alternative to FKM elastomers.

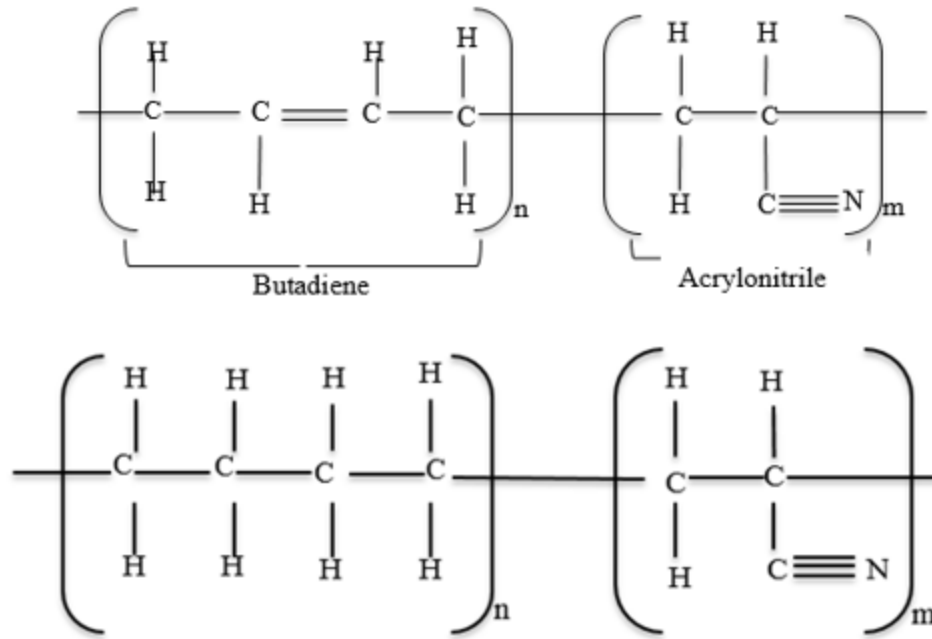
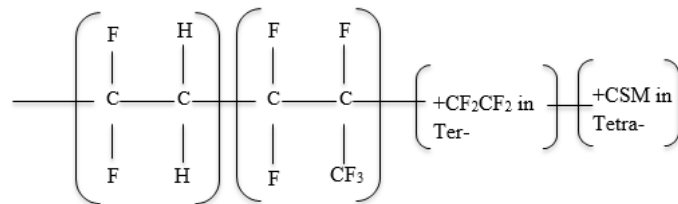
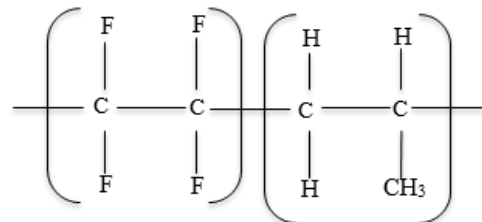

Figure 2. Structure of repeating units: a) NBR (top) and b) HNBR (bottom) (redrawn after James Walker, 2012, Issue 10.1)

a)



b)



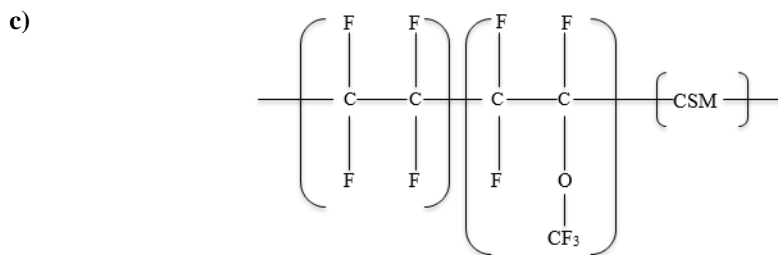

Figure 3. Structure of repeating units: FKM Viton (a), FEPM Aflas (b), and FFKM Kalrez (c). (redrawn after James Walker, 2012, Issue 10.1).

1.2 Elastomers in Oil and Gas Industry

Over the years, the exploration of complex offshore reservoirs has increased the need for high performance sealing elastomers (Debruijin et al., 2008; Tanaka, 2007; Talyor, 1990). Elastomer seals are essential for zonal isolation in vertical and deviated wells. They are often used either as O-rings (static seals) or energized seals (packers). Packers act as a strong seal, preventing influx and channeling of hydrocarbon between the production casing and tubing (Davis, 2008; Gavioli, 2012). O-rings fit to a predetermined sealing configuration with specific groove depth, width and clearance.

Harsh and challenging reservoir environments are driving the need for compatible elastomers, which require a comprehensive standard set of tests before obtaining approval. These tests are necessary to determine the seal performance at high pressures, wide temperature fluctuations, loading condition, and exposure to corrosive environment. Despite widespread use of elastomer in many oil field applications, their performance in HPHT corrosive condition is not well understood. In HPHT acidic environment, sealing elastomers can degrade considerably in a short period of time. Under harsh environment, elastomers quickly lose their performance due to thermal degradation and chemical attack.

The general coding nomenclature for elastomers follow standards such as ASTM-D1418/ISO-1629/BSI-903/A26 53505 and other standards. The major stringent industry standards that can be applied to elastomer selection and testing are issued by following organizations:

1. American Petroleum Institute (API)
2. American National Standards Institute (ANSI)
3. American Society of Testing and Materials (ASTM)
4. American Society of Mechanical Engineers (ASME)
5. International Organization for Standardization (ISO)
6. National Association of Corrosion Engineers (NACE)

Selecting a suitable elastomer for an onshore or offshore operation requires evaluation of many inter-dependent elastomer characteristics. It is often a challenge to predict the life of an elastomer seal under harsh borehole environment due to physical and chemical changes in elastomer. Table 2 lists some

of the acclaimed properties of typical elastomer in the oil and gas industry. The ability of elastomers to seal effectively depends on its physical and mechanical properties in downhole conditions. In most cases, elastomers are required to exhibit excellent performance, while retaining their physical properties at high and low temperature conditions, respectively. A good description would be the Joule-Thompson effect which occurs when there is a sudden pressure release in a subsea wellhead and blow out preventer (BOP); thus, leading to rapid change in temperature (Chen et al., 2016).

Table 2. Some of the properties of typical elastomer in oil and gas industry.

Property \ Elastomer	NBR	HNBR	Viton® (FKM)	Aflas® (FEPM)	Kalrez® (FFKM)
Max. Temperature (°F)	250	300	400	400	620
Tensile Strength (psi)	200-3500	1500-3500	500-2000	1900	2000
Steam Compatibility	Poor	Fair to Good	Poor	Excellent	Excellent
Brine High Density (Na/CaBR)	Poor	Fair to Good	Excellent	Excellent	Excellent
Brine Low Density (Ca/NaCl)	Excellent	Excellent	Excellent	Excellent	Excellent
Crude Oil. Sour (<2000 ppm H ₂ S)	Poor	Excellent	Fair to Good	Excellent	Excellent
Drilling Mud, Diesel Based	Fair to Good	Excellent	Fair to Good	Fair to Good	Excellent
Hydraulic Fluid, Oil/Water (HFA)	Fair to Good	Excellent	Poor	Excellent	Excellent

Poor – Elastomer fails when exposed to such conditions downhole, Fair to good – Elastomer perform fairly under such downhole conditions (elastomer does not deteriorate significantly), Excellent – Elastomers perform adequately under such downhole conditions.

Physical properties of elastomers significantly change with temperature. As the temperature increases, elastomers usually lose their strength (Table 3). Therefore, seal design and failure analysis should account for the effect of temperature on the mechanical properties of elastomers. To perform over a wide range of temperatures, seal glands must be designed to permit thermal expansion at high temperatures to avoid extrusion of the seal, and maintain sealing force at low temperatures when the elastomer shrinkages. Temperature change occurs in downhole environment due to flow of formation fluid from one location to another because of a kick, production or leak.

Table 3: Tensile strength (MPa) of oil-field elastomers (Klingender 2008)

Temperature	HNBR (92 Dura)	HNBR (84 Dura)	NBR (84 Dura)	Aflas (88 Dura)	Viton (81 Dura)	Viton (80 Dura)
25°C	29.4	28.3	29.1	20.7	22.0	14.5
100° C	13.0	10.3	13.8	6.3	8.1	8.1
150° C	11.2	7.5	11.3	4.7	5.7	5.6

In downhole conditions, elastomers are often in a compressed state especially when they are used in liner hanger systems, BOPs, gaskets, and seals. Under these conditions, surrounding gas molecules tend to penetrate the pores of the compressed elastomer. A sudden release of the surrounding gases causes the gas molecules within the pores to expand and escape in what is known as rapid gas decompression (RGD) or explosive decompression. As shown in Figure 4, this phenomenon reduces the sealing integrity of elastomers because they experience harsh blistering and cracking, when the expanding surrounding gas energy exceeds the physical strength of the elastomer. Elastomers with high temperature sealing performance and excellent rapid-gas-decompression (RGD) resistance, tend to have limited low temperature sealing performance due to their high modulus characteristics (Chen et al., 2016). It is often difficult to identify elastomers that have excellent rapid-gas-decompression resistance, and yet suitable for both high and low temperatures.



Figure 4. Some examples of elastomer failure caused by RGD (top row) and overload pressure (bottom row).

RGD occurs because of trapped-gas expansion when shear modulus of an elastomer is low. Under high-pressure, oil-field elastomers absorb methane, hydrogen sulfide and carbon dioxide; and

subsequently they swell and lose their strength depending on temperature and duration of exposure. When pressure abruptly reduces, the dissolved gasses expand and bubble out quickly creating blisters and cracks in the material. HNBR is known for absorbing high level of hydrogen sulfide, which limits its applicability in some cases. Problems with RGD are often mitigated by slow depressurization, which allows the trapped gases to escape before expanding. In addition, proper elastomer material selection can mitigate the problem. In general, elastomers with high modulus and low permeability provide good RGD resistance.

1.3 Properties and Testing of Elastomers

Elastomers are viscoelastic materials, which implies that they exhibit both elastic and viscous properties when undergoing deformation. This behavior is shown in Figure 5. Unlike regular metals with the Young's modulus property, this is referred to as “modulus” for elastomers, which is the stress at any given strain. Per Schweitzer P.A (2000), the modulus of elastomers is generally measured at a specific elongation such as at 300% or lower. Elastomer's viscoelastic feature makes them responsive to compressive force that is critical to sealing efficiency.

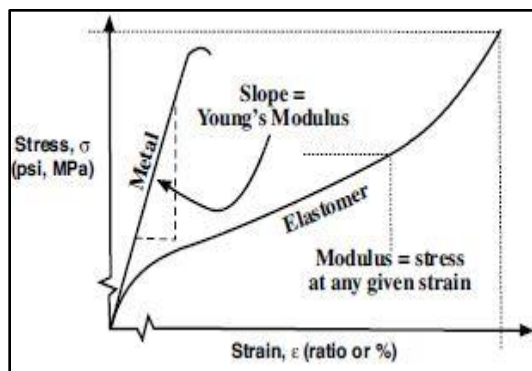

Figure 5. Stress vs. Strain profile for elastomers (from James Walker, 2012, Issue 10.1).

Recently, Wang et al. (2017) studied the sealing ability of elastomers using pressure-extrusion curves. Pressure-extrusion is the relationship between the pressure drop and the volume of extrusion of an elastomer. The curves were compared to the theoretically calculated finite elastic deformation of the seals, and the energy release rates of the cracks. In addition, they determined the elastic moduli, fracture energies, and sliding stresses of elastomers via experiments. They suggested that elastomers could have four modes of failure. The first is known as the front-end crack, which is initiated in front of the seal, and propagates through the length of the seal. The second failure is the local crack, which occurs when a crack forms at the end of the elastomer, and cuts the extruded elastomer. The third failure mode exists when the elastomer is not damaged, but allows fluid to penetrate through the interface between the elastomer and the wall, causing fluid leakage. The final mode of failure is when the elastomeric seal escapes through the sealing site, because of deformation and pressure. They concluded that pressure-extrusion curves provide

a good means of measuring the sealing abilities of an elastomer, since it corresponds with the theoretical calculations. Furthermore, study recommended this method for in-situ measurement of elastic modulus, sliding stress, and fracture energy, since they correspond to three distinct features on the pressure-extrusion curves.

Another method to characterize the sealing force of an elastomer at high and low temperatures is the compression stress relaxation (CSR) test (Tuckner, 2005). This approach provides more reliable correlations for sealing efficiency with respect to temperatures. However, it should be mentioned that the cross-links of an elastomer under compression, will break down after being contaminated by any corrosive environment for a long period. This will cause molecular chain displacement, chemical stress relaxation, and permanent deformation, leading to reduction in ability of elastomers to recover and questioning the elastomers sealing integrity (Dajiang et al., 2017). One other approach that is widely used to characterize elastomer properties is the inert gas pressurization test using nitrogen (Morgan et al., 2014; Severine and Grolier, 2005). Davies et al. (1999) compared the effects of nitrogen, air, and CO₂, on the tensile characteristics of NBR, Silicon rubber, and FKM. They performed tests at 580psi, and discovered that nitrogen had minimal impact on the tensile properties. However, increase in pressure caused more nitrogen diffusivity within the elastomer impacting the elastomer testing results.

Apart from CSR and inert gas pressurization, glass transition temperature (T_g) is another important elastomer testing property. Glass transition temperature (T_g) is the temperature range at which an elastomer begins to change from a complete solid state into a soft and rubberier form (Overney, 2000). Chen et al. (2016) conducted an extensive investigation on the T_g and high-pressure CSR pattern of four different grades of HNBR and FKM elastomers, at low temperature. Additionally, high pressure nitrogen tests were conducted on the elastomers. In the high-pressure low-temperature confined CSR test, they observed that “HNBR-4” had the highest compression strain because of its low hardness and T_g . “HNBR-1” had the lowest compression strain because it was compressed below its T_g . For all FKM samples, lower strain was observed when compressed below the T_g . After the CSR tests, they concluded that “FKM-2” showed better performance compared to other FKM samples. This is explained by a soft and rubbery behavior under high compression strain, while displaying a high stress retention during the stress relaxation test. Their performance requirement test results indicated that all the FKM samples were cracked in the range of -20.02°F to 302°F, at 10,000psi. However, FKM-2 was an exception to this observation. Figure 6 shows the cracks as potential pathways for gas leakage; hence they are undesirable for sealing.

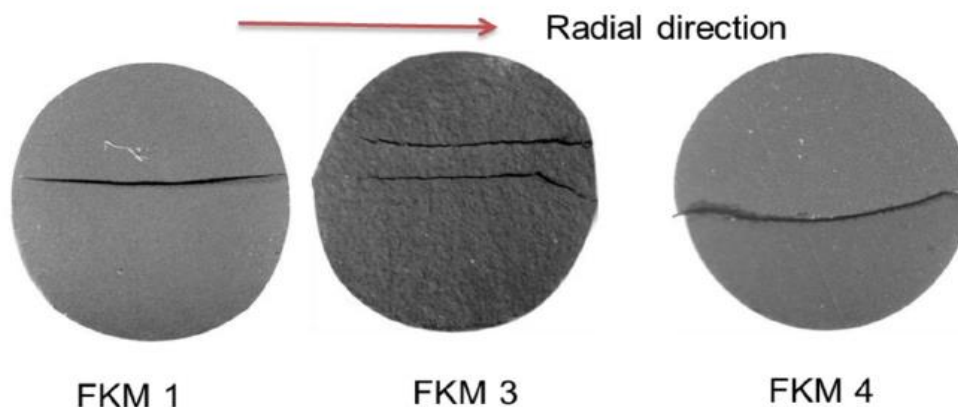

Figure 6. Cross-section of cracks on the FKM O-ring elastomers after performance requirement test (from Chen et al., 2016).

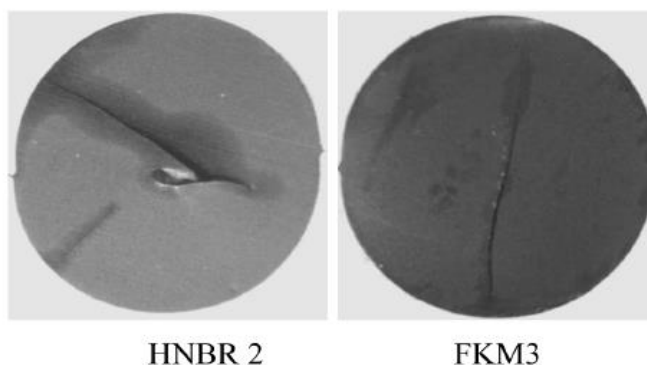

Figure 7. Cross-section of cracks on elastomer O-rings after high pressure RGD test at 302°F (from Chen et al., 2016).

Temperature is a critical factor that affects elastomeric properties. Chemical degradation of an elastomer will alter its sealing performance at low temperature (Tripathy, 1998). Experiments conducted in literature (Chen et al., 2016) using high-pressure nitrogen test at room temperature, showed no cracks and failure on the elastomer O-rings irrespective of the rate of release (3000psi/min). However, once testing conditions changed to 302°F, the results shown in Figure 7 reveal cracks that are longer than 80% of the cross-section diameter. In another study conducted to investigate temperature and corrosive fluid effect on elastomers, Tynan (2016) compared the reactivity of various elastomers to H₂S with their T_g, and high temperature performance, as shown in table 4. It was suggested that low temperature and H₂S resistance, are two properties that can exist for the same elastomer type. This was similar to one of the author’s previous observations in which an elastomer seal was selected with the combined qualities of high performance at low temperatures, excellent resistance to sour gas (H₂S), and a good amine corrosion inhibitor. Low temperature FFKM elastomer was chosen against FKM, because the design allowed for a

life of 20+ years, while maintaining a good low temperature resistance. Furthermore, study recommended FFKM as the most viable option for low temperature and H₂S conditions.

Table 4. H₂S resistance of various elastomers, at their respective glass transition and high temperature performance (from Tynan, 2016).

Elastomer Type	Resistant to H ₂ S	Glass Transition (T _g) °F	Upper Service Temp. °F
NBR	***Most reactive	-22	248
Low Temp. HNBR	Most reactive	-40	320
HNBR	**Less reactive	-22	356
FEPM (TFE/P)	*Non-reactive	41	482
Low Temp. FKM	Less reactive	-40	437
FKM	Most reactive	1.4	437
Low Temp. FFKM	Non-reactive	-22	464
FFKM	Non-reactive	32	500

Non-reactive - elastomer type does not react to hydrogen sulfide, **Less reactive – elastomer type reacts mildly to hydrogen sulfide and take a longer time to deteriorate, *Most reactive – elastomer type has a high tendency to react with hydrogen sulfide.*

Over the years, aging experiments have gained recognition as one of the commonly used methods for evaluating the behavior and performance of elastomers. These tests are conducted in special autoclaves by exposing testing samples to corrosive gas and liquid contaminants. Per Schweitzer P.A (2000), the properties of an elastomer can be destroyed only by chain growth or chain rupture. Some of the contributing agents to elastomer aging are: atmospheric ozone and moisture, heat, sunlight, CO₂, H₂S, CH₄, drilling fluids, and brine amongst other. These agents are used to evaluate the sealing integrity of elastomers. During elastomer aging, chain growth will usually decrease elongation and increase hardness and tensile strength, while chain breakage will have the reverse effect on these properties (Schweitzer P.A, 2000). Elastomer hardness is defined as the resistance of an elastomer surface to indentation by a Shore A durometer. Figure 8 shows that elastomer hardness tends to increase with an increase in temperature. Increase in hardness by temperature explained by mobility and crosslinking of the elastomer molecular chain (Jin et al., 2008). Furthermore, study highlighted that changes in the order of the sulfur bonds occur with temperature increase.

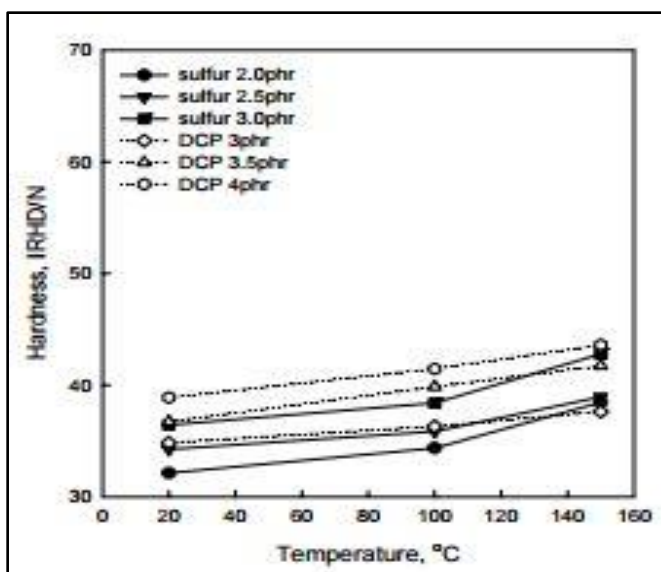

Figure 8. Hardness vs. Temperature (from Jin et al., 2008).

Cong et al. (2013) published experimental results of aging cell study for HNBR samples in aqueous solutions of H_2S and HCl . The authors used nuclear magnetic resonance, infrared spectroscopy, and X-ray photoelectron to analyze the samples. The H_2S experiment was carried out at 1000 ± 100 psi and $212^\circ F$, while the HCl experiment was carried out at $284^\circ F$. They observed that exposure of HNBR to HCl solution resulted in a slight reduction of tensile strength and ultimate elongation because of the hydrolysis of the $C \equiv N$ group to $-OH$ or $O=C-NH_2$. Once exposed to H_2S solution, all three parameters (tensile strength, ultimate elongation, and hardness) deteriorated significantly. Given the high reaction activity of H_2S , homolysis and heterolysis are two reactions of H_2S that may take place during elastomer degradation. Heterolysis converts H_2S into H^+ and HS^- . H^+ causes the acidic hydrolysis of the $C \equiv N$ group, while HS^- attacks $C=O$ due to its strong nucleophilicity, giving rise to $C=S$ and $C-C=S$ groups (Figure 9). During homolysis, H_2S can alter into mercapto radicals of H^\cdot and HS^\cdot . HS^\cdot reacts with macromolecule radicals of the elastomer that forms at high temperatures. It then forms to mercapto compounds. These compounds undergo further pyrolysis to form macromolecule radicals to react with mercapto radical (HS^\cdot) in a continuous reaction cycle. This chain of reactions increases the $C-S-C$ bonds. The breakdown of the triple bond in the CN group to double and single bond, as shown by these reactions, is responsible for the deteriorating properties of the elastomer. Studies showed that during exposure period to H_2S solution, the structure of HNBR will change due to formation of new chemical compounds.

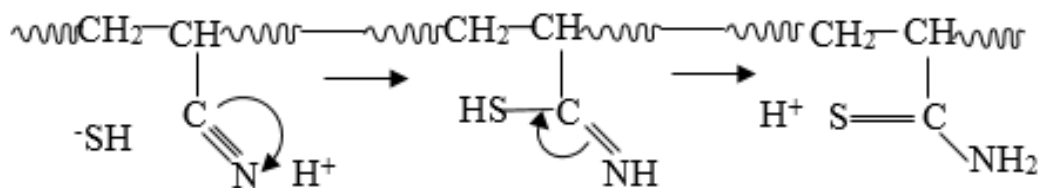

Figure 9. Nucleophilic reaction mechanism showing the breakdown of the acrylonitrile group in HNBR (redrawn after Cong et al., 2008).

Fernández et al. (2016) studied the elastomeric properties of two NBR's (high and low ACN) using two separate autoclave tests in liquid and gas contaminants respectively. They varied the concentration of crude oil compositions to obtain three liquid contaminants, while using H_2S and CO_2 as the gas contaminants. In the presence of crude oil, tests were conducted at 150°F and 1000psi, for 168 hours. After the crude oil aging, the results from their hardness test revealed no more than 5% change from the original elastomer hardness. A maximum volumetric swelling of 3.1% was recorded. Their compressive set test results showed high permanent deformation values within acceptable limits. Decrease in tensile strength and elongation at break was also recorded. The decrease in tensile strength was more severe with the NBR that was aged in the crude oil, which had the highest percentages of saturates and aromatics.

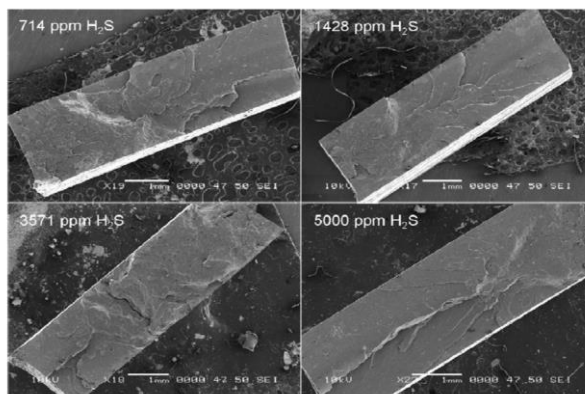

Figure 10. Scanning Electron micrographs of NBR aged with H_2S (203°F , 168 hrs.) (from Fernández et al., 2016).

Exposure of an elastomer to sour fluid conditions such as H_2S , at elevated temperatures, will accelerate aging and degradation. This process can provide some information about the long-term stability of elastomers (Tynan, 2016). In the H_2S aging experiments by Fernández et al. (2016), the H_2S concentration was increased from 714ppm to 5000ppm. A reduction in the elastic properties were observed, causing elastomers less retractable. Tensile strength and elongation at break properties decreased significantly with increase in H_2S concentrations. The SEM image in Figure 10 shows an increase in the brittle fracture surface with increase in H_2S concentration. The authors concluded that permanent deformation of the elastomer is a function of the H_2S concentration. In addition, they recorded

an increase in the volumetric swelling and permanent deformation of the elastomers with increase in CO₂ concentrations. Increase in permanent deformation was finite, and plateaued at very high concentrations of CO₂. Increase in hardness was recorded for low CO₂ concentrations. The SEM image in Figure 11 shows a decrease in the brittle fracture surface of the NBR with increase in CO₂ concentrations.

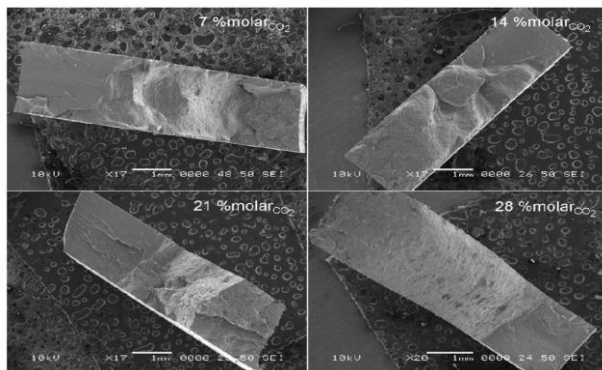

Figure 11. Scanning Electron Micrograph (SEM) of NBR aged with CO₂ (203°F, 168 hrs.) (from Fernández et al., 2016).

Dajiang et al. (2017) characterized NBR and HNBR samples by aging the elastomers in the presence of liquid and gaseous CO₂, under mechanical compression. Their control group sample was compressed at laboratory ambient temperature and pressure. Two separate groups of elastomers were aged in liquid and gaseous CO₂ respectively for 168 hours, at 230°F and a CO₂ partial pressure of 145 psi. Compared to the control samples, an increase in elastomer weight was recorded for the aged elastomers. Increase in weight was more pronounced with the elastomers that were aged in liquid CO₂. They also observed that the reduction in elastomer hardness was more severe in the gaseous contaminant, compared to the liquid contaminant. Samples were compressed by 25% of their original height for 24 hours at ambient temperature, and was left to recover for 30 minutes. They recorded compression set results in the range of 9.94% to 17% and 10.33% to 26.02% for NBR's aged in liquid and gaseous CO₂, respectively. Furthermore, study reported similar values for the HNBR samples suggesting that mechanical loading will increase the damage in the elastomers in the presence of CO₂.

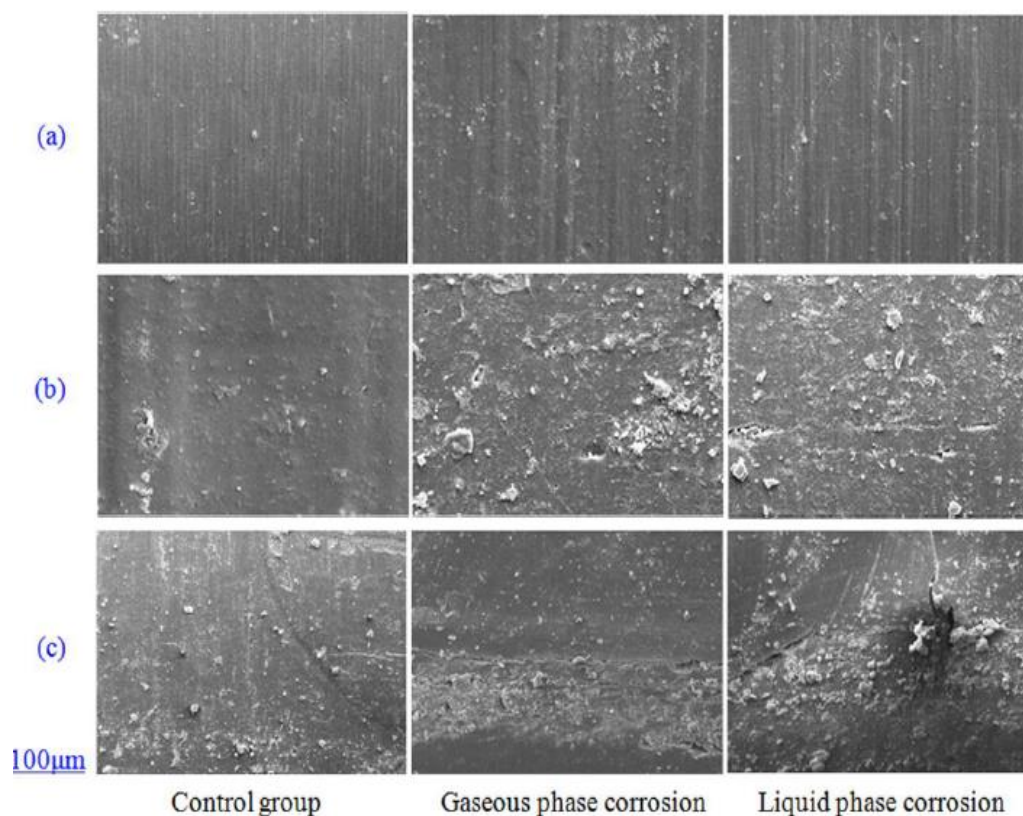

Figure 12. SEM images of HNBR after aging at 0lbf (a), 1349lbf (b), and 2698lbf (c) (from Dajiang et al., 2017).

In addition, Dajiang et al. (2017) observed slight deformation in the HNBR control group, compared to an obvious swelling and deformation revealed by the aged samples. Figure 12 shows HNBR SEM images, at various compressional loads. They observed holes, fractures, and more damage in the aged HNBR samples. Furthermore, their energy dispersive spectroscopy (EDS) results for the 2698lbf compressed samples showed decrease in the weight percent of the main constituent elements (C, O, Si, and Ca). They concluded that elastomer swelling, and damage tend to increase with increase in compressional load in liquid CO₂ corrosion, and appear to be more severe than gaseous CO₂ corrosion.

In addition, to corrosive gases, other contaminants such as drilling fluids can deteriorate elastomers. The behavior and performance of an elastomer can be impacted by drilling fluids contamination. Drilling fluids can alter the physical and chemical properties of elastomers that are used in drilling equipment severely affecting the equipment's life and function (Badrak, 1994). The degree to which drilling fluid can alter elastomeric properties and/or composition depends on the type of drilling fluid, temperature, pressure, and type of elastomer. For instance, during a drilling operation, positive displacement motors (PDMs) experience chunking when the elastomer in the stator reaches its fatigue limit (Guidroz, 2011). Kubena et al. (1991) investigated performance of elastomers that are used in downhole drilling equipment, particularly PDMs. In their study, four elastomers (hydrocarbon,

chlorinated, nitrile, and fluorinated elastomers) were contaminated with five non-aqueous fluids (NAF) base liquids (diesel oil, mineral oil, low aromatic content mineral oil, ester, and glycerol/water mixture). When a PDM is heated above the aniline point (1400 °F) of a diesel oil base fluid, the aromatic portion of the diesel will penetrate the elastomer compound, causing it to swell. Aniline point defined as the temperature at which a known volume of a clear aromatic compound (aniline), dissolves totally in a specific volume of oil to form a non-cloudy solution. High temperatures accelerated chemical attacks on stator rubbers, and hence reduces its mechanical properties. Previous field studies revealed that PDMs which were used with mineral/low-toxicity NAF, had twice the service life they would have had when used with diesel based NAF. Study concluded that no specific elastomer can fit to work in all types of drilling fluids.

Other corrosive fluids such as brine, can potentially influence the performance of an elastomer. Super absorbent polymers (SAP) often swell insufficiently when they are in contact with saline formation water (Bosma et al., 2006). Wang et al. (2015) developed a new water-swellaable elastomer that can swell in the presence of high salinity (20+ %) and divalent brines (CaCl_2 and CaBr_2). These new elastomers developed by mixing nanocomposite microgels with NBR. Figure 13 reveals that the new elastomer showed better swelling ratios compared to SAP (reference 1 and 2), in the CaCl_2 and CaBr_2 at 200°F. A similar performance was observed in presence of high level of brine. In addition, other test results revealed that the new elastomer has better tensile strengths after swelling, as well as enhanced breaking elongation properties compared to the current water-swellaable elastomers.

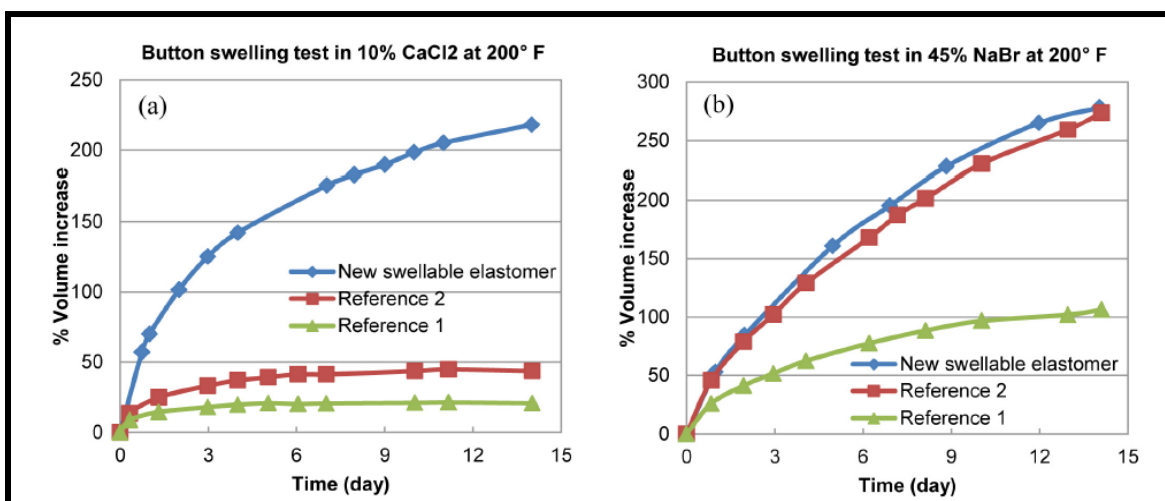

Figure 13. Swelling curves of button-shaped samples tested (a) 10% CaCl_2 at 200°F (b) 45% NaBr at 200°F (from Wang et al., 2015).

Another wide application of elastomers in downhole is expandable liners and swelling packers. These are used to control oil flow from each lateral, to improve total oil recovery. Qamar et al. (2012)

conducted longevity tests on a full-scale rig. Table 5 shows the test matrix containing packers made from different swelling elastomers, exposed to saline water or crude oil. The tests were conducted at a constant pressure of 1000 psi but at varied temperatures. W1 represents low-salinity while W2 and O1 represents high-salinity and oil-swelling elastomers respectively. The authors did not disclose the actual formulation of the elastomers for confidential purposes. However, their results showed that units 1, 2, and 6 failed, and did not seal within the first two weeks of the test. Unit 5 sealed then de-sealed, after several months of exposure. Unit 7 showed good sealing at lower pressures but failed at a pressure of 1000 psi. Units 3 and 8 had good sealing performance. They concluded that elastomers tend to swell and seal earlier when in contact with low salinity brine at high temperatures, compared to high salinity brine. Additionally, water-swelling elastomers swell and seal faster than oil-swelling elastomers (Qamar et al., 2012; Qamar et al., 2009; Pervez et al., 2012).

Table 5. Experiment design details for the longevity test setup (from Qamar et al., 2012).

Unit	Elastomer Type	Swelling Medium	Temperature
3½-in swell packer inside 7-in casing			
1	W2	12% brine	73°F
2	O1	Crude oil	73°F
3	W2	12% brine	122°F
4	O1	Crude oil	122°F
4½-in swell packer inside 7-in casing			
5	W2	12% brine	73°F
6	O1	Crude oil	73°F
7	W2	12% brine	122°F
8	W1	0.5% brine	73°F
9	W1	0.5 brine	122°F
Perspex demonstration unit			
10	W1		73°F

1.4 Summary

It can be summarized that currently there is a gap in understanding performance of elastomers in downhole conditions. Studies show accelerated degradation of elastomers in higher temperature and under different corrosive conditions such as CO₂, H₂S and HCl. Additionally, performance of elastomers is impacted differently by changing concentration of corrosive gases. In one study, tensile strength and elongation at break properties decreased significantly with increase in H₂S concentrations.

One study summarized effect of drilling fluid contamination on elastomer properties. Drilling fluids can alter elastomeric properties and composition depending on the type of drilling fluid,

temperature, pressure, and type of elastomer. Another study investigated sealing performance of expandable liners and swelling elastomers and concluded different behavior at low and high salinity brines.

It is crucial to know “fitness for service” of various elastomers in packers, casing seals, liner hanger and other downhole tools. An existing challenge is to know the exact formulation and type of elastomers used in downhole equipment since formulation and processing method of elastomers impact their properties. Review of many manufacturing catalogues and websites indicates very little information disclosed as per exact formulations of elastomers used in different downhole tools. In addition, limited data (in forms of published testing data and laboratory procedures) is available to assess performance of elastomers downhole.

Furthermore, corrosive downhole conditions may accelerate failure of elastomers posing more challenges in applications of these materials in HPHT wells. Additionally, elastomer failure may result in underground loss of well control incident in harsh downhole conditions. Therefore, an urgent need exists to conduct a comprehensive research study to investigate and assess the engineering design, performance, reliability and testing of the current and new elastomer material grades for offshore oil and gas activities.

2 Shallow Flows, Gas Migration in Shallow Wells, Cement Design, Integrity and Evaluation

Shallow flows usually occur because of high pore pressures from undercompaction and overpressurization of sands during rapid depositions. They can consist of water, gas, and formation fines. Shallow flows are identified as one out of every five surface casings potential hazard (Bogaerts et al., 2012). They can jeopardize the integrity of a well by preventing hydraulic isolation after a cement job, leaving a path for flow into other shallow formations or sea beds. Gas leakage in the annulus has been recorded as a major hazard in drilling and completions operations. Shallow gas flow often results in well control issues. Shallow kicks can occur because of swabbing, core volume cutting, improper hole fill-up on trips, abnormal pressures, insufficient mud weight, gas cut mud, lost circulation during drilling or cementing, and gas migration through cement column. Shallow gas blowouts have been the major cause of the loss of offshore drilling rigs than any other type of well control problem. Records show that one out of three blowouts occur because of shallow influx (Adams and Kuhlman, 1990; Prince, 1990).

One of the major occurrences that can result from shallow flow is known as cratering. Cratering is the caving in of already drilled wells, and in such cases the drilling rig normally goes under with the collapsing well. Current well control practices usually call for the shutting in of a well when a kick is encountered, provided there is sufficient casing to contain the kick. However, in the presence of a shallow gas, casing strings may not be set deep enough to keep the underground flow under control. The flow breaks through and disturbs the foundation of the rigs, leading to the formation of craters and the loss of both the rig and associated marine structures. A modern approach makes use of diverter systems that sidetracks the flow away from bottom supported rig platforms. In cases where the diverter is too restricted, the pressure created in the formation still exceeds the formation breakdown pressure, and a crater can still be formed irrespective of the fact that the well is not shut in. Although there is insufficient statistical information regarding cratering, they are mostly related to shallow gas blowouts. Design concerns and risks involving the cementing of shallow casing, sub mudline and liner systems are not new which at least two studies were conducted by MMS (Mineral Management Service) to address these issues. In 1986, Hughes compiled information in relation to blowout incidents. The author recorded that 82% of Texas blowouts, 77% of Louisiana blowouts, and most of the blowouts experienced in Outer Continental Shelf (OCS) showed presence of gas. Danenberger's study in 1993 showed that 58 out of the 83 blowouts that were encountered between the years of 1971 and 1991 on the OCS of the United States had gases associated with them. This was a strong indication of the severity of shallow gas flows and cratering, costing significant expenditure to the operators.

Bourgoyne et al. (1995) ascertained and described various probable sedimentary failure mechanisms that can lead to cratering. They developed correlations for the estimation of sediment

breakdown resistance and to evaluate well design and well control procedures. Their sediment failure mechanism was subdivided into two sections: the first was for fluid migrations to unconsolidated sediments and the second was for crater formation. The mechanism for upward fluid migration include casing failure, failure of the cement bond at the casing-sediment interface, rock tensile failure because of hydraulic fractures, rock shear failure in permeable zones, and upward fluid migration through fault planes. The recognized cratering mechanisms include borehole erosion, formation liquefaction, caving, and piping or tunnel erosion. They also showed how soil boring data can be useful in accurately estimating overburden stress and formation breakdown pressure. To prevent shallow gas kicks, use of seismic surveys were recommended to identify potential shallow gas zones prior to drilling. Using a heavier mud was recommended in shallow portions of the well.

Shallow gas is usually encountered at shallow subsurface depths of 300 ft with low fracture gradients. They often result to blowouts in the open hole section usually below the conductor or surface casing because of gas migration through the cement (Adams, 1990). Industry general practice allows the driller to close the well and circulate formation fluid influx out of the well. However, in shallow formations this action may result underground blowout or the formation being broached to the surface. Therefore, the gas is required to flow in a safe manner until the zone is completely isolated. This process can cause the erosion of plugs and pipework since the flowing gas is accompanied by large volumes of abrasive sand particles (Prince, 1990).

Some steps have been taken by the industry over the years in regards with shallow wells casing and cement design considerations. These include API RP 65 (Cementing Shallow Water Flow Zones in Deepwater Wells) and API RP 65 – Part 2 (Isolating Potential Flow Zones During Well Construction). Some other new standards such as API Recommended Practice (RP) 19LH (Liner Hangers) is currently being drafted by an API subcommittee. Specifications of downhole liner hangers will be specified in this new standard.

2.1 Gas Migration

Gas migration is defined as gas entry into a cemented annulus with the potential to provide a flow path into the wellbore for gas, water and hydrocarbons. Gas migration can cause fluid flow through annulus, and surface. If not detected, gas flow will have severe consequences such as underground blowouts or if marginal it can cause sustained casing pressure. Drilling industry recognized this problem during the 1960s and since then intensive research has gone into investigating this problem. Various aspects of gas migration have been described in the literature as following:

- Experimental and field case studies (Stone and Christian, 1974; Garcia and Clark, 1976; Cook et al., 1983; Al Buraik et al, 1998; Bour and Wilkinson, 1992)

- Development of technical recommendations (Levine et al., 1979; Tinsley et al., 1980; Cheung and Beirute, 1982; Dean and Brennen, 1992)
- Developments of new products and techniques (Kucyn et al., 1977; Watters and Sabins, 1980; Cheung and Myrick, 1983; Siedel and Greene, 1985; Matthews and Copeland, 1986)
- Empirical prediction techniques (Sutton et al., 1984; Rae et al., 1989)

Gas migration phenomenon can be caused by numerous factors; and can occur at various times. Root causes of gas migration have been attributed to i) fall in annulus hydrostatic pressure; and ii) pathways in annulus through which gas can migrate (Nelson and Guillot, 2006). Primary causes of gas migration are related to the cementing process involving several factors. Gas migration through a cemented annulus can be categorized into three types based on their migration path (Talabani et al., 1997). The first type occurs between the casing and the cement; a situation whereby gas molecules migrate through the void created between the casing and cement. A common practice to remedy this problem is adding the appropriate amounts of magnetite to the cement slurry. The second type of gas migration occurs through the void created between the cement and the wellbore wall. This void is created when the filter cake that is formed at the wellbore adversely affects the bonding process. Anchorage Clay and some other additives can be used to eliminate this problem in drilling. The third gas migration path exists because of hydrostatic pressure changes that appear in the cement during the setting phase. This is also referred to as primary gas migration when gas molecules migrate into the cement mainly because of loss of hydrostatic head. To better understand gas migration, Stiles proposes three stages of cementing: 1) during placement or immediate; 2) post-placement (short); 3) post-setting (long). It is important to understand all the physical and chemical process cement slurry goes through from liquid slurry to semi-solid and solid states. When the cement hydrostatic pressure in front of a large volume of gas “pocket” drops below the pressure in the gas zone, gas influx takes place (Pinto, 2012). On the other hand, secondary gas migration occurs much later after cement placement is complete. This is because of mechanical and thermal stresses which compromises the integrity of the hydraulic bond or the integrity of the cementing materials (Rupak, 2007). Per Mineral Management Service (MMS) safety alert (2003), annular flow related to cementing surface casing has been identified as one of the most frequent causes of the loss of well control incidents in the Gulf of Mexico. When zonal isolation is not achieved, and gas molecules migrate behind casing, it charges the shallow formations. These shallow formations become a formidable challenge when there is little proximity between the pore pressure and fracture gradients in the operational mud window. In such situations, the gas can broach the casing, leading to a blowout.

Here a review of major studies in literature regarding gas migration is presented:

Carter et al. (1973) presented a laboratory model of gas migration in deviated boreholes by focusing on properties of cement slurries needed for successful primary cementing jobs. Their research showed that the parameters directly related to gas migration include cement filtration control, borehole mud removal, and effective hydrostatic head (hydrostatic pressure exerted by the mud, spacer, and cement slurry). In addition, the study presented factors that reduce gas migration during and after primary cementing. These factors summarized as centralization of casing strings and increased flow rates during displacement amongst others.

Garcia et al. (1976) presented findings of a fieldwork study. This study was done to trace gas migration as it occurred in the wellbore. The investigations showed that gas migration occurs under two conditions. The first is when there is fluid loss in the cement slurry. Secondly, there is an uneven setting of the slurry, such that there is absence of hydrostatic head communication between the bottom of the hole and the mud column directly above the set cement. They provided guidelines to predict formations that have potentials for gas migration. Furthermore, the study recommended practices that curb annular gas flow.

Christian et al. (1976) presented a method to calculate the allowable filtrate loss rate for a cement slurry during various stages of cementing. They stated that without fluid-loss control, cement slurries may be unsuccessful in transmitting full hydrostatic pressure before their initial set. The authors showed that increasing concentrations of fluid-loss additives yield to lower cement permeability and lower gas migration's potential. In addition, their field results demonstrated that gas migration can be successfully prevented with cement slurries that have a fluid loss in the range of 50 ml/30 minutes. Cook et al. (1977) in a similar study showed that filtrate loss control is just as important as the slurry thickening time or its compressive strength development. Both studies concluded that maximum fluid loss control should be used in cement slurries when cementing across zones varying in pressure. This would help to minimize gas leakage.

Webster et al. (1979) based on laboratory tests and field results identified the relationship between water separation in a cement slurry and loss of hydrostatic head of the cement. They observed that the use of clay in regulated amounts can be used to control the amount of free water in cement slurries. They concluded that reduction of free water to zero eliminates the potential of flow after a cementing job.

Bannister et al. (1983) simulated a wellbore model to study the incursion of gas into cement. Two design approaches were used to reduce gas conductivity (the relationship between gas flow and loss of hydrostatic pressure). One of these approaches was to deposit impermeable cement filter cake against the formation. The other approach involved the use of a self-activating slurry that interacts with incoming gas to form an impermeable barrier. Results from their investigation showed that the impermeable filter cake

deposition, hinders gas invasion so far as it is in place, but once broken, gas flow becomes unhindered and rapid.

Cooke et al. (1983) presented field measurements of annular pressure and temperature during primary cementing operations. Pressure and temperature measurements were conducted in seven wells via sensors to investigate the causes of fluid migration behind casings. They highlighted multiple causes of fluid migration, but focused on one, ‘the loss of pressure in a cement before the cement sets’. Their investigations disclosed that annular pressure measurements indicated fluid entry into the wellbore when the formation pore pressure exceeds the pressure exerted by the cement. The sensors showed the extent of vertical movement of the migrated fluid. The study concluded practical steps that can be followed to help minimize flow induced by loss in annular pressure.

Beirute et al. (1990) presented a method to scale down field wellbore parameters to laboratory conditions for accurate testing of cement recipes to be used for controlling gas migration. Their method assumed the gas bearing formation to have substantial permeability, gas volume, and thickness to invade the annulus and pressure-charge the cement. The study concluded some criteria for selecting cement slurries in wells with potential gas migration problems.

Bour et al. (1992) presented an analytical method to quantify the potential and severity of gas flow. They showed that appropriate gas migration control cementing systems can be designed once the flow potential has been established. Compressible cement was recommended for use to combat gas migration problem. Al-Buraik et al. (1998) discussed solutions to shallow gas migration problems with the use of lightweight latex slurries, and right-angle set (RAS) latex slurries amongst others.

Most recently, Bois et al. (2017) presented a gas migration model that investigates two different stages of fluid and porous solid in the life of a cement slurry. Their models allowed for the computing of cement properties, and state of stress, at any depth and time. In addition, models showed that the opening of a micro-annulus is not necessarily associated with gas migration. However, gas will invade the cement sheath when the cement pore pressure drops below the pore pressure of the formation. The study highlighted importance of gas flow rate and diffusivity in the cement sheath. Furthermore, they concluded that gas may use multiple leakage paths during migration to reach the surface leading to shallow gas blow out or leaking into another reservoir.

Overall, optimizing cement mix design and process can help in mitigating gas migration. It must be noted that not a single factor alone can prevent gas migration, but rather a combination of factors depending on the well condition is required. Some of the key properties of cement in context of controlling gas migration can be summarized as:

- Fluid loss

- Gel strength development
- Cement shrinkage
- Permeability
- Free fluid (free water)
- Mud removal
- Microannulus
- Mechanical and chemical failure of cement sheath

2.2 Shallow Gas Loss of Well Control (LOWC)

Shallow gas blowouts are the most common types of blowouts, and ideally require a case-by-case analysis to develop the most appropriate control techniques. However, records have shown that shallow gas blowouts have similarities in their causes. Adams et al. (1990) showed that shallow gas blowouts have some form of relationship with cementing operations. They provided information about drilling procedures, equipment selection, and response procedures from various rigs in cases of shallow gas blowouts. Some of the recorded causes were: bridging and diverter system failures, flow outside casing, and cratering. Some documented gas handling or kill techniques include: kick prevention, shut-in on shallow flows, use of pilot holes, heavy and dynamic-heavy slug, dynamic kill, and incorporating the measurement while drilling (MWD) approach. Studies recommended a shallow hazard survey prior to drilling a proposed location. Mud weights and casing setting depths should be optimized to handle possible influx and well control. Riserless drilling or the use of riser connectors that can release at high angles is a viable alternative. Adams et al. (1990) concluded that pilot hole drilling with controlled rate of penetration (ROP), offers a better chance of early detection. Prince et al. (1990) discussed the drilling procedures to reduce the probability of a shallow gas kick. The study concluded operational procedures such as controlling rate of penetration and mud circulation rates for circulating gas out of the well in timely manner. In addition, slowing down tripping process was recommended to reduce risk of swabbing.

Field surveys carried out as far back as in the 80s show that annular gas flows accompanying cementing defects (incomplete sheaths in annular space) are major problems in shallow casing strings. Tinsley et al. (1980) provided some data on the remedial costs of wells due to gas flows. Another study conducted by Martinez and McDonal (1980) discussed the most hazardous form of gas migration as the one behind the conductor or surface casing reaching the surface in a very short period of time. They described some distinct occurrences resulting to annular gas flow as followings:

- Insufficient historical information on hazardous locations,
- Unsuccessful cement mixtures or cementing procedures,

- Inadequate hole preparation, mechanical devices and procedures during cementing,
- Unreliable cement slurries,
- Insufficient cement column hydrostatic pressure,
- Inability to detect channel location in the annulus.

Furthermore, studies showed annular gas flows due to drilling fluids displacement. Some of the factors that affects mud displacement include: mud conditioning, mechanical devices on the casing, casing movement, cementing techniques, slurry design, change in velocity due to eccentric annuli, washouts, variable filter cakes, and inclined holes. Drilling mud that has not been successfully displaced but remains in the wellbore-casing annulus can become a channel for gas flow. Although the displacement efficiency of mud is dependent on the fluid flow model, it also depends on the mechanical conditions such as the effect of casing string rotation or reciprocation; where casing rotating helps remove gelled mud, and thus prevents gas migration.

In a study conducted by the Petroleum Safety Authority (PSA) Norway on the review of well control incidents from 2003 to 2010 on the Norwegian Continental Shelf (NCS), it was revealed that more than 28% of well control incidents were due to technical failures such as technical well design (cement, casing, and plugs) and improper primary barrier/mud column (PSA Report, 2011). Shallow gas incidents were quite significant. During the period of study (2003-2010), 146 well control incidents were registered from which more than 18 were categorized as shallow gas or high-risk shallow gas. The study recommended to include shallow gas, pore pressure and length of casings as typical topics for the risk review.

In the United States OCS, several shallow gas well control incidents have been reported. One of the incidents of shallow depth occurred in February 2013, at the Main Pass Block 295 in the Gulf of Mexico. District investigation of the incident concluded the cause due to the 18 " liner top seal assembly and cement barrier between the conductor casing and surface liner. A QC-FIT evaluation report published in 2014 (BSEE, 2014) revealed potential causes of the incident as due to casing hanger seals, and cement column in conductor/surface liner annulus. The key findings from investigation report revealed the followings; 1) lack in robustness of current industry practices and regulations related to pressure testing, 2) quality control on downhole pressure equipment design, testing and realistic rating in situations of loss of well control incident and lifetime conditions; and 3) review and analysis of well design regarding shallow liner hanger sealing assembly, and the need for improving best industry practices.

In a recent ExproSoft’s report to BSEE on updates of loss of well control incidents (LOWC), incidents grouped into two categories. The first category is called shallow zone LOWC events. These occur before the installation of the blowout preventer (BOP) on the wellhead. The second category is deep zone LOWC, and they occur after the BOP has been landed on the wellhead. The report stated that approximately 50% of LOWC that occurred during drilling, were shallow events. For the deep zone drilling incidents, approximately one half of the kicks that occurred were detected late. In the same section, BOP failure accounted for 50% of the incidents while the rest were because of formation and cement failure. Shallow zone incidents typically occurred due to unexpected high well pressure or during the cement setting process. ExproSoft’s report classifies major causes for shallow zone kicks as i) unexpected high well pressure or too low of mud weight; ii) annular losses (swabbing); iii) poor cement; and iv) unknown (Figure 14). The report further recommends some important factors to focus on in shallow zone drilling such as awareness of shallow gas, cement waiting time, cement fluid loss and annulus pressure while waiting on cement.

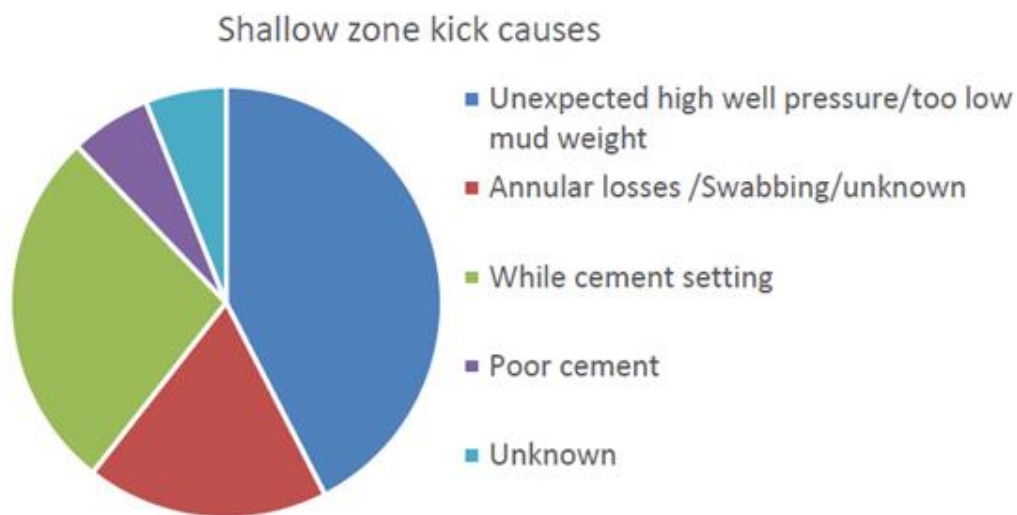

Figure 14. Shallow zone kick causes summarized in ExproSoft’s report to BSEE.

2.2.1 Loss of Well Control Incidents While Tripping

Loss of Well Control while tripping happens due to reduction of wellbore pressure as a results of insufficient mud density, loss of mud column height, and “swabbing” effects. When a tubular (e.g. drillstring, casing, liner) within a fluid-filled wellbore is raised or lowered, fluid pressure variations are produced. The pressure decrease resulting from an upward pipe movement is called “Swab Pressure”. Improper estimation of this pressure can lead to Loss of Well Control while tripping. The earliest paper written on the subject of swab and surge pressures was composed over 80 years ago (Cannon, 1934). Cannon sought to explain the reasoning behind why blowouts frequently occurred while the drillstring

was being withdrawn from the wellbore. Pioneering the term “swabbing pressure”, Cannon was able to provide a qualitative overview into the effects of mud weight, viscosity, gel strength, and tripping speeds on downhole swab pressures.

Danenberger (1993) studied 87 blowouts in the Outer Continental Shelf (OCS) from 1971 to 1991. His studies revealed that 21 of these accidents were due to swabbing occurred while tripping, in addition to other contributing factors. Equipment failure, cementing and drilling into other wells accounted for the causes of the remaining incidents. In addition, well incident data reported to the Offshore Safety Division of the Health and Safety Executive Board in the UK showed that one-third of kicks between 1992 and 1993 were taken while tripping out (Element and Brown, 1992).

Izon et al. (2007) studied Loss of Well Control incidents from 1992 to 2006. The study revealed 13% of kicks were due to swabbing. These statistics show “swab” is one of the key causes of potential kicks while tripping (Figure 15).

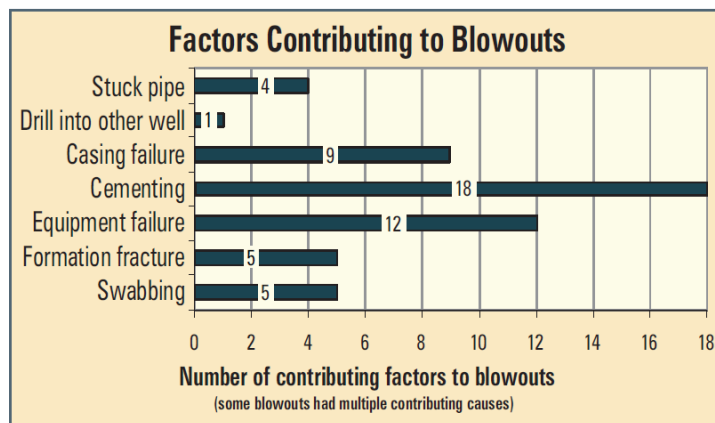

Figure 15. MMS Study of blowouts in OCS from 1992 to 2006 (from Izon et al., 2007).

Swabbing and well control hazards can be more critical in shallow sections. Shallow gas blowouts usually occur at depths for which the fracture gradient is low. At these depths, the tolerance between the fracture gradient and the formation pressure overbalance with the drilling mud is small. Therefore, relatively small amounts of swabbing or core volume gas can initiate a gas kick (Adams et al., 1990). They can also occur in the open hole below the conductor or surface casing or due to gas migration behind the cement in surface casing. Conventional shut-in and kill techniques cannot be used to control shallow gas kicks.

Swab and surge pressures are significantly affected by the wellbore hydraulics and consequently the in-situ downhole pressure. While tripping in, large swabs can be induced during the stage of deceleration of the drillpipe due to pressure transients and fluid inertia (Crespo and Ahmed, 2012). The pressure transients are created by the decompressing fluid and can be lower than hydrostatic. The

maximum swab can occur when fluid deceleration and pipe and wellbore contraction occur simultaneously (Crespo et al., 2012). Due to the cumulative effect of the underbalanced periods, sufficient volume of light formation fluid can be swabbed into the wellbore thereby reducing the hydrostatic head enough to induce a kick (Rudolf and Suryanarayana, 1997). Several parameters such as fluid rheology, tripping speed, pipe diameter to hole ratio, and drill-pipe eccentricity can impact “swab” pressure. The total pressure that arises can depend on type of mud, its viscosity, velocity of the pipe movement and pipe length. Each type of drilling fluids has its unique flow characteristics which depend on its rheology. Tripping speeds can influence the flow regimes and hence, the pressure variation - which increases with the increase in speed. Besides that, other parameters such as annular space for fluid flow plays an important role. The effect of annular space becomes more prominent in case of horizontal and inclined wells where small eccentricity in drill-pipe translates into higher degree non-uniformity in annular clearance. In addition, in deviated or extended reach wells since formation pressure doesn’t change over the lateral section, tripping out from the well will be more critical than vertical wells. Furthermore, for a swabbing induced kick, the shut-in pressures will remain zero if the influx stays in the horizontal section (Santos, 1991). Furthermore, low clearance liners produce large fluid friction pressure loss and reduced in-situ speed relative to surface speed. The effect of transient swab becomes critical at casing shoe and float collar in case of low margin between pore-pressure and fracture pressure. Mitchell (2004) in an analytical study showed the occurrence of multiple swabs having magnitude between -60 to -80 psi during tripping. In another study, Mitchell (1988) reported the velocity profile of the pipe ranging from 0 ft/sec to 6 ft/sec (Table 6) based on Burkhardt surge data (Burkhardt, 1961). Study presented a dynamic surge/swab model by coupling pipe and annulus pressures.

Table 6: Pipe velocity profile with time (from Mitchell, 1988).

Time (sec)	Velocity (ft/sec)
0	0
4.5	0
10	5
13.5	6
16	2.5
17.5	0

There are several additional factors and operational conditions that can induce a kick while tripping; for instance, lost circulation due to surging can cause a kick. During connections, pressure drop will cause an underbalanced situation which can impact total bottom hole pressure and cause kicks. This

can be more critical in smaller diameter wellbore. It is shown that the swabbing effect during tripping out of the well can be reduced by pumping out of the hole. When the well is circulated during swabbing there is a lower pressure drop over the bit than when the pump is off. The pressure drop over the bit is also dependent on the pump rate used, an increase in pump rate gives a smaller pressure drop when the pipe is pulled at a high speed.

The resulting downhole pressure response during swabs exhibits the same transient character as the surge data but with a much smaller amplitude and in the opposite direction. The magnitude of the swab pressure reduction at the lower gauge depth is greater, as one would expect.

Experiments showed that swab event with an average pipe velocity of 2.3 ft/sec easily creates a large enough flow fluctuation to offset the 150 GPM (Gallon Per Minute) flow rate and stop return flow during the swab (Wagner et al., 1993). Transient effects including swab pressures are not quite visible in steady state models and increases due to downward movement of pipe. With downward movement of pipe, fluid accelerates in pipe and maintains its motion against friction losses. Under the event of stopped pipe, fluid still in motion, negative pressure is required to put the fluid at rest. This event can assist the occurrence of kicks (Wagner et al., 1993; Wolski et al., 2014). Additional factors impacting well control conditions while tripping includes fluid inertia, fluid compressibility, wellbore elasticity, axial elasticity of moving pipe, temperature-dependent fluid rheology for both water and oil-based muds, simultaneous circulation, open or closed pipe, pipe movement, well deviation, and eccentricity (Mitchell, 1988; Fontenot et al., 1974; Bing et al., 1995). Tang et al. (2014) showed that at low annular flow rate, the swab pressure increases with increase in eccentricity and directly related to plastic viscosity and yield point. Besides that, swab pressure drop increases with increase in pull out of hole (POOH) speed to a certain maximum annular flow rate and decreases with rising POOH afterwards which can be attributed to thixotropic and shear thinning behavior of drilling fluid.

Review of loss of well control incidents while tripping at US OCS shows at least two incidents in 2013 and 2014. A kick incident occurred at Vermilion Block 356 of GOM for the Rowan Louisiana in 2014. The root-cause analysis showed that while short trip, and stuck pipe in “Gumbo” layers, the over-pull caused reduction in wellbore pressure and “swab” effect. The investigation panel (BSEE 2015a) reported causes of loss of well control incidents due to:

- Existence of high risk “shallow gas”
- Short trip in the high-risk zone and swab effect

The investigation panel also recommended more robust and comprehensive hazard analysis in high risk drilling such as shallow gas, developing proper operational procedures, reduce drilling rate in high risk zones and more training to crew in detecting and mitigation of such hazards.

In another incident in 2013, the crew for Walter Oil and Gas Corporation while “tripping out” encountered a kick which was elevated to blowout. The BSEE investigation panel (BSEE, 2015b) made following recommendations (BSEE) as cause of initial loss of well control:

- Improper and insufficient completion fluid density
- Ignoring effect of temperature on brine density
- Failure to detect kick in early stages

Important to consider is lack of alternative protocols in fast well control events where the crew cannot accomplish some of the early steps.

2.3 Wellbore Integrity and Cement Design

Well integrity issues are most commonly associated with the cement quality, casing corrosion, dynamic drilling and production pressures, and completion and abandonment complexities. Well barriers elements comprised of primary and secondary barriers are established to cater with these issues. Primary well barrier consists of fluid column and secondary barrier involves cement, casing, wellhead, high-pressure riser, and Blow-out Preventer (BOP). The fluid column is the main hydraulic barrier during drilling activities which helps in maintaining overbalance state of the borehole with regards to the formation. This overbalance pressure condition prevents any fluid influx in the wellbore (NORSOK-D010, Figure 16). NORSOK-D10 states that “the well barriers shall be defined prior to commencement of an activity or operation by identifying the required well barrier elements (WBE) to be in place, their specific acceptance criteria and monitoring method.” Furthermore, it recommends assessment of risk of drilling into shallow zones for all wells with having a model to define the shallow gas risks and operational constraints. Consequences of drilling in shallow gas shall be evaluated by considering type of rig, water depth, drilling with or without riser, casing and cementation and weather conditions. For a well to leak, there must be a source of fluid in addition to breakdown of well integrity barriers. Driving force for leaks often are excess pore pressure in some of the formations while drilling. A robust well construction plan must consider enough well barriers for both short and long integrity of a well. Cement is one of the critical barriers through life cycle of a well from drilling to abandonment. Many of the well integrity issues are associated to poor cement design. Short and long integrity of cement sheath are both important to ensure an effective zonal isolation through life of the well. Typical cement properties, such as tensile and compressive strength, porosity, and permeability can be altered due to cement compositional variation reacting with downhole fluids. Also, the dynamic pressure and temperature conditions during drilling and production exert a cyclic load on cured cement, and sometimes initiates cracks in the cement. These cracks then have the potential to act as pathways for fluid migration. Several mechanisms (chemical and physical) can cause cement failures in downhole environment discussed in next section.

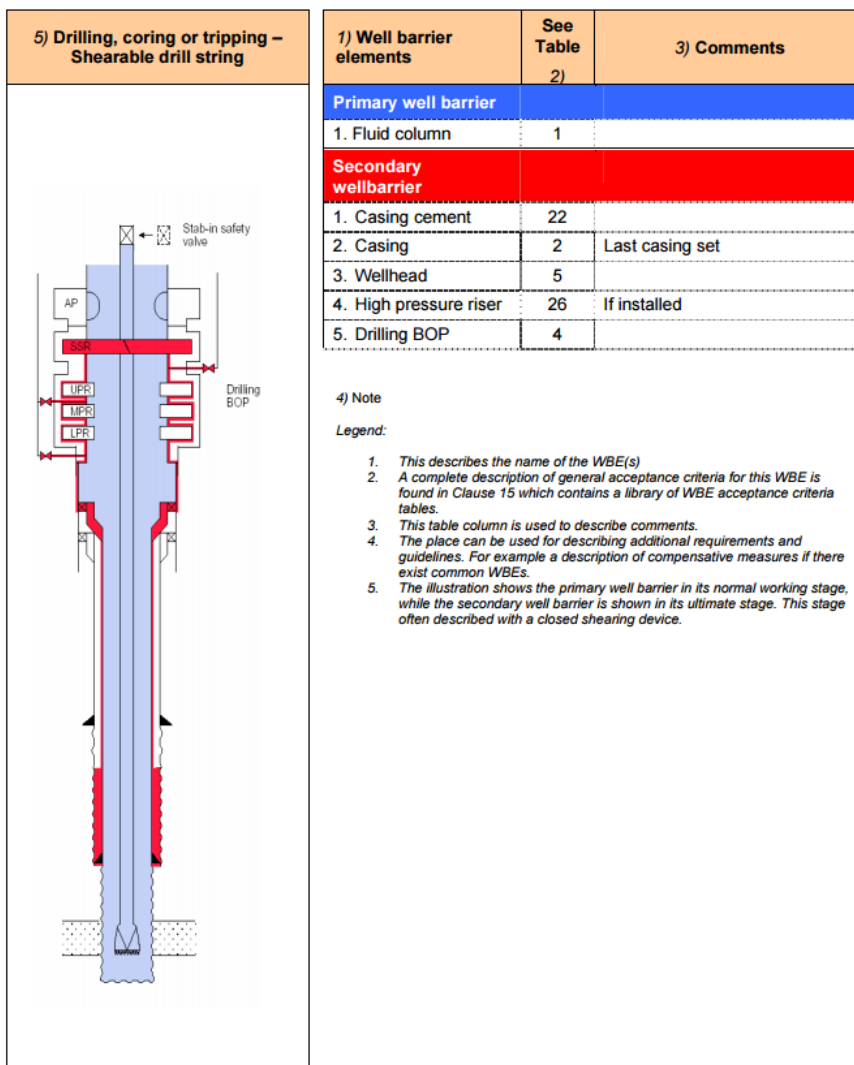

Figure 16. Primary and secondary well barriers from NORSOK-D010 (drilling, coring and tripping with shareable string).

2.3.1 Mechanisms for Failure of Wellbore Integrity

Loss of wellbore integrity is mainly a consequence of time-dependent formation leakage caused by fluid flow, solute transport, chemical reactions, mechanical stresses, annulus quality, casing degradation, seal degradation, and defective abandonment operation over a wellbore’s life cycle. These parameters can be divided into three high-level categories: chemical; mechanical; and, physical. Ultimately, these aspects contribute to the evolution of leakage pathways along and through wells, and potentially assist the movement of fluid migration to the surface, as shown in Figure 17.

Potential leakage pathways can be mainly attributed to casing corrosion and thread leakage, casing-cement interfaces, gas migration through the cement due to micro-annuli, void spaces and

fractures, mud channels, fluid communication between the formations and the cement, fluid communication between the cap rock and the wellbore cement and gas migration through damaged cap rock. Acidic environment caused by the presence of CO₂, H₂S, and water promote corrosion of casing and dissolution of cement. Thread leaks are mainly reported as connection failures. This poses a major problem since 90% of the tubular failures recorded are associated with connection failures (Schwind et al., 2001). The poor placement or presence of cement and non-proper removal of filter cake leads to gaps at cement-casing and cement-formation interfaces. Poor quality of cement often leads to mud channels or existence of micro-annuli within the cement. Extra mechanical stresses due to pressure change over time, thermal stresses induced by fluid injection, chemical stresses due to the chemical reaction of downhole and injected fluids with cement, and steel result in fractures being formed. Also, the stresses translate to increased permeability of cement and eventually, pathways for fluid to move into unintended zones.

Other major problems with poor cement design is sustained casing pressure (SCP). As per studies and data from US Mineral Management Service (MMS), there are 8,000 to 11,000 wells in the Gulf of Mexico with SCP (Nelson and Guillot, 2006). In 1999, “there were 3810 wells with surface casing vent flows and 814 wells with gas migration problems in Alberta” per Alberta Energy and Utilities Board. Poor cement design, improper balances of pressures while cementing operations, pipe movements and chemical attacks are primary reasons. Some of these factors are later discussed in this report.

2.3.2 Cement Design and Integrity

Well construction often require that conductor pipes be cemented in unconsolidated and relatively young geological formations. Weak formations and pressured sands tend to present narrow margins between pore pressures and fracture gradients. These tight drilling margins pose multiple challenges in managing weighted mud, equivalent circulating density (ECD), and drilling shallow over pressured formations with a riser. If these pore pressures cannot be controlled, the zone begins to flow large volumes of salt water, which carry with it pieces of unconsolidated formation. Such flows can lead to washouts, ineffective cementing, hole re-entry issues, damaged casing, and sand compaction. One of the critical factors to consider in cement design for shallow flows is transition time. Transition time is the period during which the cement slurry changes from being a true hydraulic fluid to the point where it is solid enough to prevent annular gas flow. Sabins et al. (1982) developed test techniques to study the beginning of transition period, and conducted tests to delineate the condition of cement that would prevent gas migration. If cement pressure, adjacent to a high-pressure gas zone is maintained at a value equal to or greater than the gas reservoir pressure, then annular gas flow can be prevented. Once the pressure in the annulus is less than the pressure of an adjacent gas reservoir, gas entry can begin to occur (Tinsley et al.,

1980). Their tests showed that critical static gel strength can occur 10 minutes after stopping the cement pumps. Additional results showed that for normal thickening times and slurries with low fluid loss, SGS (static gel strength) stabilized from 21 lbf/100ft² to 104 lbf/100ft². The authors emphasized that once an increase in SGS occurs, it can reach values exceeding 250 lbf/100ft² within one hour.

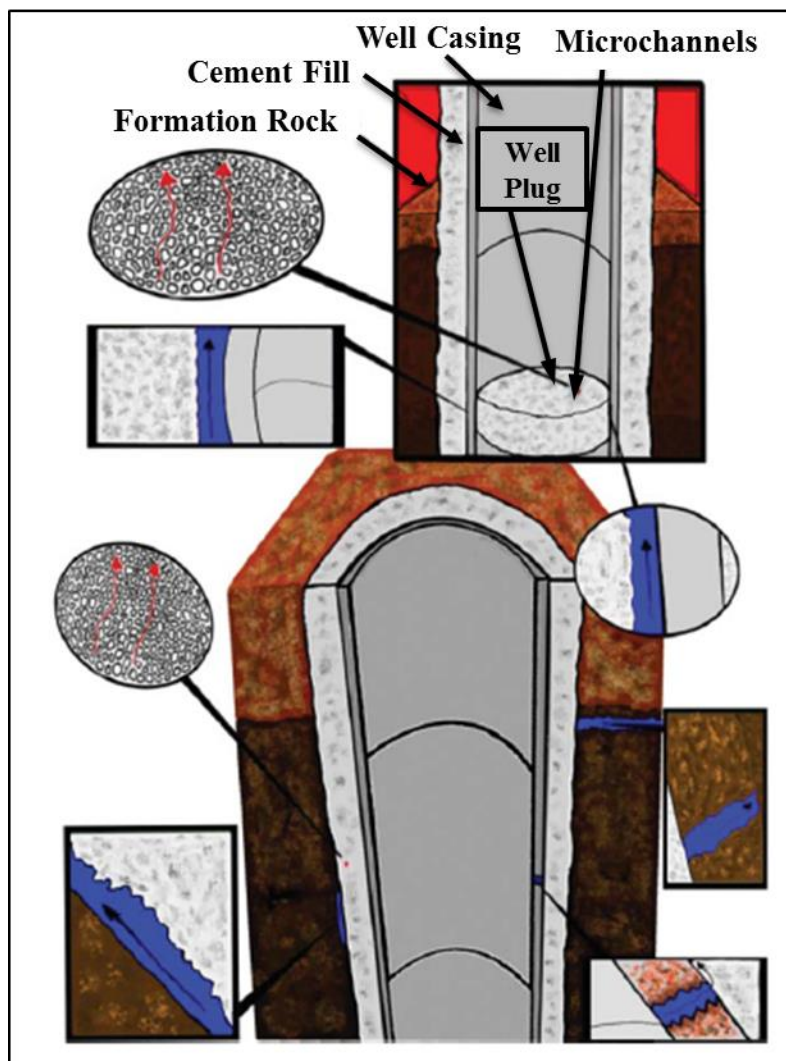

Figure 17. Potential Leakage Pathways in Wellbores (from Salehi, 2013).

It is important to mention that cement must remain in its slurry form until it is fully displaced to the desired downhole location. However, after placement, cement should set fully and develop adequate compressive-strength within a brief period. To test the effects of thickening time on early compressive strength and gel-strength development, Sabins et al. (1986) studied a variety of cement slurries in a wide range of well conditions. These slurries included lightweight filler type cements, neat cement slurries with fresh and seawater, fly-ash slurries, and silica-stabilized slurries with fluid loss additives and dispersants.

In their evaluations, static gel strength commenced immediately after static conditions. This static gel strength development of the cement slurry offered some vital information. The first was the gas flow potential, while the second was the gel strengths above which the cement would subject the formation to excessive pressure. They emphasized that the static gel strength of cement slurry is more closely related to the type of cement slurry than the thickening time. However, with thickening times exceeding of 10 hours, gel strength development is restrained. The authors concluded that most of the tested slurries developed static gel strengths greater than 100 lbf/100 ft² in less than 20 minutes, and a reasonable increase in thickening times does not significantly change 12 and 24-hour compressive strengths.

Shallow water flows (SWFs) are major shallow drilling hazards that have led to the abandonment of prospective wells (Eaton, 1999). In additions, SWFs are common in deep-water GoM operations. Shiflet et al. (2005) discussed a three-component technique that has been developed to mitigate gas migration in three wells in the Eugene Island Block 273 gas field. The first component in this technique was to drill a gauge hole, while the second component involved mixing and pumping the correct cement slurry. The final process was the ability to utilize mechanical barriers to create obstructions to the gas migration. The three-component technique eliminated gas migration into the cement column of the three wells. Unsuccessful zonal isolation in shallow flow situations can result in the loss of a well and/or expensive remedial work. Cement systems like foam cement and optimized particle size distribution (PSD) cement have been used to control shallow flows in oil and gas wells. Irrespective of the cement system, O’Leary et al. (2004) highlighted the properties of a typical cement slurry for preventing shallow flows, and can be summarized as: 1) no free fluid, as free fluid would lead to cement slurry volume reduction as the water is removed, 2) the slurry should be stable with complete absence of slurry settling or sedimentation, which causes density differentials in the cement, and leads to insufficient hydrostatic pressure for well control, 3) the slurry is recommended to have a fluid loss of 20–50 ml/30 minutes, since rheology, thickening time, and density are dependent on the available fluids, 4) sufficient thickening times for uniform cement placement around the casing, and 5) short critical hydration period.

Surfactant and foam cements have been used over the years to prevent gas migrations and to mitigate SWF. Surfactant cement is a conventional slurry to which a foam generating surfactant is added. The surfactant immobilizes gases from the formation by converting them into highly viscous low mobility foam, while lowering the slurry’s surface tension to prevent bubbles from coalescing and being mobile. Developed in 1973 by the Institut Francais du Petrole (IFP), surfactant cements were deployed as a means of curbing gas migration economically. The hydration process of Portland or hydraulic cements is dependent on water wetting of the chemical components of the cement. Oil-based mud (OBM) impedes the hydration of the cement slurries by oil-wetting its components, and this affects the development of

compressive strength. Harder et al. (1992) explored the use of ethoxylated nonyl phenols (ENP) as a counter-active surfactant in cement slurries. Thickening time, rheology, consistency, fluid loss, non-destructive and destructive compressive strengths were tested at varying levels of OBM contamination with several OBMs. The range of ENP concentrations were from 0.5% to 2.0% by volume of slurry. The authors observed that some cement slurries with 30+% OBM percentage would not produce any compressive strength until over 48 hours of wait on cement (WOC) time. One surfactant free slurry with 40% OBM revealed a 24-hour compressive strength of 700 psi, while the same slurry with 2% ENP developed a compressive strength of 1470 psi after 24 hours. They recorded major improvements in rheological compatibility for all OBM samples, and controlled high yield points by adding small amounts of ENP. Hibbeler et al. (1993) described some case studies regarding the cost effectiveness of surfactant cements. The major properties of a good surfactant are: excellent compatibility with the cement, high tolerance to calcium or pH sensitive environments, appropriate effect on slurry transition time, and gas blocking ability at a range of temperatures and pressures. They tested two surfactants: Ethoxylated Lauryl Ether (ELES) and Ethoxylated Nonyl Phenol (ENP). The ENP surfactant revealed unsatisfactory results because it caused longer transition time, high free water, and was ineffective in gas control. ELES demonstrated right angle setting between 120°F to 190°F. The right-angle set is a cement property that characterizes the change in cement slurry consistency from 30Bc to 100Bc in a short time. It is characterized by a 90° bend in a cement consistency versus time. Concentrations from 1.0% to 2.5% by volume of mix water was found to be optimum. They also observed that ELES surfactant reduced slurry's plastic viscosity and yield point while increasing the thickening time. Surfactant cements tend to block gas flow at the cement-formation interface, while providing cost effective gas control.

Cowan et al. (1993) made use of numerous surfactant additives to improve the performance properties of cement. Some surfactants used included ENP, Ethoxylated C12-C15 linear alcohol sulfate, Coco amidopropyl betaine, and Nonionic fluorocarbon surfactant blend. These surfactants were added to Portland cement with varying concentrations. Interfacial sealing tests were conducted on them and the surfactants proved to improve interfacial sealing between cement and pipe. To control fluid loss, they also combined surfactants like Sodium n-decyl sulfate, Sodium lauryl sulfate, Ammonium perfluoroalkyl sulfonate, Alkylether hydroxypropyl sultaine, Deceth-4 Phosphate, Nonoxynol-6 Phosphate, Alkyl phosphate ester, and Cocoamidopropyl with polymers. This combination enabled them to obtain the desired fluid loss at a lower cost since, the addition of surfactants to polymers decreased the total amount of polymers needed for the same fluid loss control. In conclusion, they discussed how surfactants lead to less shrinkage. The cement with surfactant had approximately 3% less shrinkage compared to cement slurries without surfactants at the same temperature.

Faul et al. (2000) designed lightweight foamed-cement (LFC) slurry systems that uses only liquid additives with Portland cement, creating a low-density slurry with relatively short transition times. For SWF preventative cement compositions, the desired thickening time is 3-5 hours at 65°F, and a compressive strength of 400-500 psi at a temperature of 55°F is required. They obtained two Class A Portland cements from different suppliers, and all slurries were foamed to 12 lbm/gal. Their results showed a shorter transition time for LFC systems, and this helped to prevent potential SWFs, while maintaining zonal isolation and adequate cement placement time. For large scale testing, Class H cement was foamed to 12.5 lbm/gal for large scale tests. The thickening time at 65°F was 4.17 hours. Compressive strength was recorded as 360 psi and 600 psi, at 45°F and 55°F respectively.

Traditional compressible fluids (foamed cements containing nitrogen) have been discussed as one of the cementing systems for mitigating shallow gas and liquid flows. However, this approach has generated safety concerns, complicated logistics, lack of reliability, placement problems, and long-term integrity issues. To eliminate these concerns, special cement systems based on packing volume fraction and ratios of sized particles have been developed, and used successfully in the Gulf of Mexico. This special cement system called as particle size distribution (PSD) system (O’Leary et al., 2004). They concluded that the PSD system had early gel strength and compressive gel strength development because of the low water content. In addition, low density features minimized risk of lost circulation incidents in shallow-flow prone zones. Furthermore, set cement exhibited ultra-low permeability ensuring zonal isolation throughout the entire life of the well. Another study in Offshore Kalimantan reported application of a particle-size slurry system (Hartoni et al., 2000). The area of Offshore Kalimantan is characterized by low fracture pressure and shallow gas zone problems; therefore, the new slurry system was able to handle these issues.

In addition to foam and surfactant containing cements, salted cements are also used to mitigate dissolution in massive salt environments that have the tendency to compromise the cement sheath to formation bonding. In addition, they can be applied to cement unconsolidated and loose offshore shallow pressure zones, with high tendency of shallow breakouts and shallow fluid influx. First applications of salted cement discussed by Carter et al. (1966). After setting, cement expansion occurs because of internal pressure exerted by salt crystals. In a recent study, Teodoriu et al. (2015) investigated the effects of salt concentration on the thickening time, compressive strength, elastic modulus, and set cement permeability of API Class-G cement. They observed that the 5% by weight of water (BWOW) salted cement slurry had the shortest thickening time and the highest compressive strength. Authors reported 32% increase in strength after 24 hour and 72 hours, and 11% increase after 7 days. Strength retrogression was observed

at elevated temperatures between 1 and 7 days, and the cement failed between 212°F and 302°F. Low NaCl concentrations between low and moderate temperature and pressure conditions yielded desired setting speed, hydraulic integrity, rheology, and excellent accelerating effects on Portland cement hydration. Furthermore, they concluded that 5% \pm 2.5% BWOW NaCl concentration had the best effects on the tested cement properties.

Cement with latex and elastomer powders are reported in literature for use in mitigating gas migration. Latexes are aqueous dispersions of polymer particles such as surfactants which impart stability to dispersion. The mechanism of latex in cementing can be described as an acting impermeable polymer barrier when hit by gas. This, helps in mitigating gas flow in the cement column. Other latex benefits include acting as a fluid loss control agent and/or a lubricant. Studies have shown latex improving shear-bond strength of cement (Parcevaux and Sault, 1984). These additives were first introduced by Parcevaux et al. (1984). Latex field applications have been presented in several studies reported in the literature (Evans, 1984; Rae, 1987; Drecq and Parcevaux, 1988). In a recent study, Kelessidis et al. (2014) presented laboratory studies on two slurry systems one including latex additives. They conducted their assessment on two non-foamed cement slurries at room and elevated temperatures and pressures. The first slurry was a Class-G neat cement and the second slurry was a Class-G cement mixed with micronized silica, and latex. They recorded low fluid loss for the second slurry, compared to its original form at all pressure and temperature conditions. In addition, the second slurry showed prolonged dormant time but had a shorter transit time. The prolonged dormant time provides an extended time for cement slurry placement, while quick transit time indicates a better cement-water cohesive bond. Study concluded that a combination of micronized silica and latex will initially retard hydration in the acceleration period due to the coalescence of the latex particles in the slurry, and thus forming a plastic film that covers the C-S-H gel.

In addition to using latex as cement additive, elastomer powders were used to counteract pressure changes during the setting phase of cement. Talabani et al. (1997) observed that adding an elastomer rubber powder to the cement would eliminate cement-body micro fractures with an optimum cement elastomer mixture. The selection of the appropriate elastomer powder during a cement job can eliminate micro cracks in the cement by eliminating the pressure variation in the setting process of the cement.

2.3.3 Key Factors Impacting Cement Design

Cement hydration, water concentration, temperature and operational factors such as mud cake removal are some of the key factors impacting cement integrity. Slurry design is a key aspect of cement hydration mechanics and its relationship to gas migration. Water concentration and cement hydration are two of the most important factors to consider in cement design. Controlled water-loss cement slurries can

be used to mitigate annular gas flow. Appropriate amount of water must be added to make the slurry pumpable, without losing its density. The density of a cement slurry will remain approximately constant at low free water but decreases at high free water levels (Webster and Eikerts, 1979). As shown in Figure 18, cement columns in general tend to lose hydrostatic pressure over time, and if designed inadequately, would allow the migration of gas into the cement column since the wellbore pressure would be below the formation pressure (Tinsley et al., 1980; Levine et al., 1979; Martinez and McDonal, 1980).

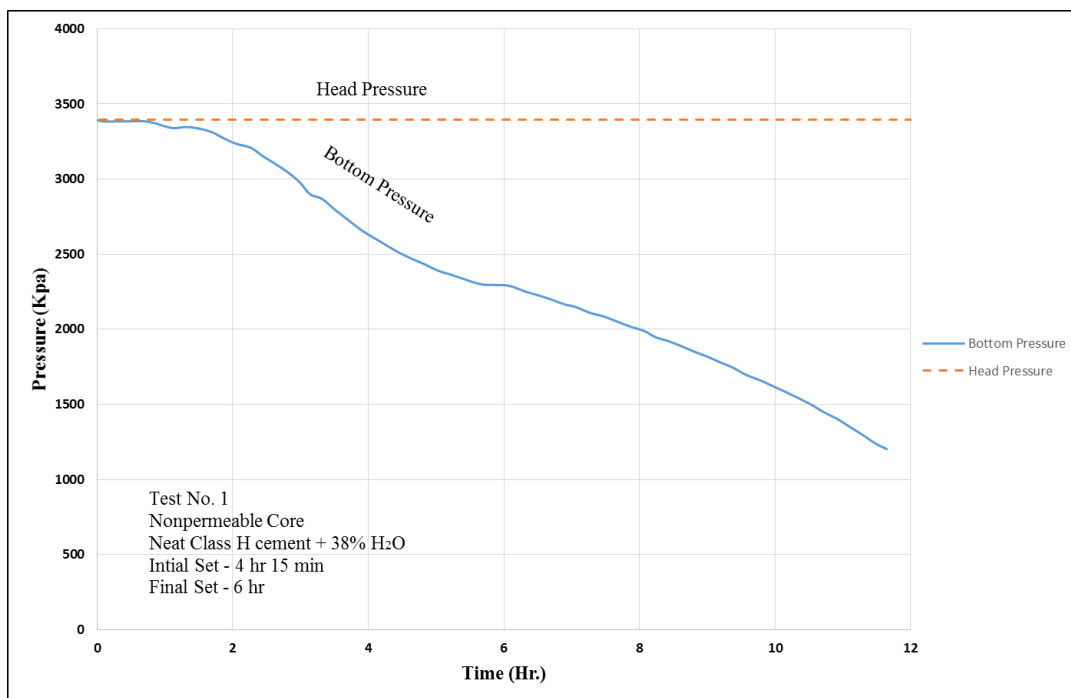

Figure 18. Cement column loses hydrostatic pressure vs time (reproduced after Tinsley et al., 1980).

In addition to water concentration, cement hydration is also a critical process impacting gas migration and wellbore integrity. When water is added to cement, each phase dissolves partially, leading to the establishment of a supersaturated solution with respect to different hydrates, which can precipitate (Gauffinet-Garrault, 2012). Hydration is the terminology used to describe all the reactions involved. Cement hydration is a complex dissolution-precipitation process. Once cement is exposed to water, hydrates are formed. The hydration component of silicate phases is calcium hydroxide (CSH). This phenomenon can be explained by chemical reactions of Tricalcium silicate (Ca_3SiO_5) or C_3S (Barret et al., 1983). Tricalcium silicate is the main phase of Portland cement clinker. Different than tricalcium silicate, hydration of $Ca_3Al_2O_6$ or C_3A is fast. This fast reaction dissipates hydroaluminum precipitates (C_3AH_6). This rapid formation of calcium hydroaluminate causes premature stiffening of slurry often described as flash set (Gauffinet-Garrault, 2012). In first few seconds of cement exposure, tricalcium

silicate comes into contact and forms a connected structure (Figure 19). As more CSH precipitates, the structure becomes more reinforced which makes it very difficult to break the gel. One important concept is the inability to destroy CSH structure once they are formed, even by mechanical stress applied during mixing, - in other words, the process is irreversible. CSH phase comprises 65% of fully hydrated Portland cement at ambient conditions, therefore acts as primary binder of set cement. After initial hydration, a period of low reactivity called an "induction period" starts. Rheological properties of cement do not significantly change during this period; however, substantial hydration resumes (Nelson and Guillot, 2006). Because of larger concentration of C_3S , they dominate formation of CSH gel leading to early strength development of cement. Final strength of cement is more impacted by C_2S hydration. Although the mechanism of C_2S hydration is very similar to C_3S . The process is much slower. Since the hydration of silicate phases is exothermic, hydration stages can be detected using calorimeter experiments. Cement hydration defines many cement properties such as viscosity, yield strength, thickening time and compressive strength after setting. Various factors including cement type, design, additives, temperature, mixing method and mixing process affect hydration history. Unfortunately, the effect of mixing on hydration is not well understood.

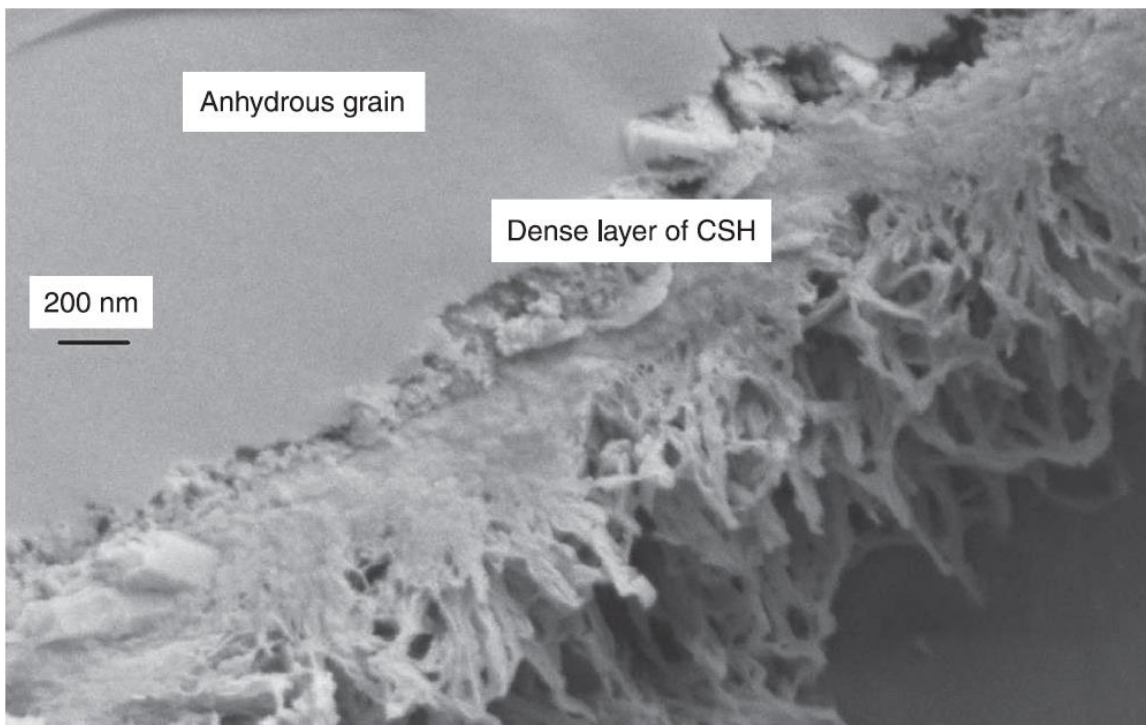

Figure 19. SEM image of tricalcium silicate hydrated grain and CSH (from Gauffinet-Garrault, 2012).

Amongst other downhole conditions, temperature is one critical factor that impacts the properties and integrity of cement slurry. Low temperature levels negatively affect the hydration rate, thickening time, compressive strength development, and shear stress of the annular cement sheath; thus, prolonging

the waiting-on-cement (WOC) time and a surge in the cost (Zhang et al., 2010; Wang et al., 2011; Wang et al., 2016). Wang et al. (2016) investigated the acceleration performances of calcium chloride (CaCl_2), lithium chloride (LiCl), and potassium chloride (KCl). The Class-G oil well cement samples were prepared with water-to-cement ratio of 0.44 and with addition of chlorides. The measured properties were adiabatic temperature rise, rheological and thixotropic properties, static gel strength, and thickening time. Compressive strength was tested after the slurry was cured at different conditions (pressure and temperature). These curing conditions were designed to represent the different well depths including shallow conditions. They also used micro-test analyses for phase characterization and hydration products studies of different cement powders to understand the effects of chlorides on the cement hydration processes. Their results revealed the order of accelerating abilities as: $\text{CaCl}_2 > \text{LiCl} > \text{KCl}$. Calcium chloride (CaCl_2), and lithium chloride (LiCl) effectively shortened thickening time while enhancing compressive strength of set cement at low temperatures, while KCl had limited promotion. The best accelerator was CaCl_2 . However, it increased adiabatic temperature, causing poor rheological and thixotropic properties of the cement slurry. The authors concluded that lithium chloride LiCl showed better performance in comprehensive strength. Additionally, it had lower adiabatic temperature rise under low-temperature conditions.

Operational procedures such as selection of compatible drilling fluids, and proper mud cake removal are other factors impacting a successful cement job. Bogaerts et al. (2012) described three components of a successful cement job for complete zonal isolation: good mud removal, appropriate slurry design, and proper centralization to ensure evenly distributed flow around the entire casing. The authors recommended cement slurry properties to prevent shallow flow hazards such as zero volume of free fluid and a critical static gel strength time of less than 45 minutes. Furthermore, study concluded successful field application for some of the shallow wells drilled in Asia.

Whitfill et al. (2000) discussed three aspects to drilling fluids and cement design, with respect to shallow water flow prone zones. The first was the use of specialty fluids for drilling, while the second was the benefits of an all-liquid additive approach for cement slurries. In the third aspect, they proposed an operational flow chart for controlling water flows in shallow water flow environments. The ideal drilling fluid for shallow flows must provide both hydrostatic pressure, as well as chemical protection of the unconsolidated formations; while the ideal cementing fluid provides sufficient thickening and transition times. A shallow, well-developed, and geo-pressured formation can produce large amounts of brine in an uncontrolled flow, during a drilling operation. The unconsolidated nature of shallow formations, as well

as high fluid viscosities encourages large volumes of produced sands which results in wellbore enlargement.

Other operational factors such as mud removal has been a subject of debate throughout literature because of its effect on cement quality and zonal isolation. Many of cement issues caused by incomplete mud displacement leaving mud layers or channels on the wellbore walls. Research concerning mud removal and cement placement was first initiated in 1930s and since then several solutions have been recommended in the literature. However, it is generally challenging to ensure complete mud removal in actual field operations. Some of the remaining technical challenges include the effects of casing movement during placement, chemical interactions between fluids and unstable flow situations (C.W. Sauer, 1987; Nelson and Guillot, 2006). Some of the previous studies focused on mud conditioning and controlling rheological properties such as reducing the mud's yield and gel strength to improve mud removal and cement placement. Other studies described importance of pipe rotation for better mud displacement (Sanchez et al., 1999; Philip et al., 1998). Some other techniques such as pipe jetting, reverse circulation and casing vibration were presented for removing immobile muds (Way et al., 2000; Sutton and Ravi, 1991). The presence of mud cake is another challenge for optimum cement placement. It can be detrimental to the cement-formation bond, which impacts overall cement integrity. In addition to reducing annular clearance, when in contact with cement, existing mud cake can further dehydrate to create an empty space. Several studies in literature have focused on understanding mud filter cake and its implication on drilling and cementing operations (Ravi et al., 1992; Cerasi et al., 2001; Amanullah, 2012). Some of the new studies in literature investigated effect of new additives on mud cake to improve design placement. Hao et al. (2016) studied mud cake solidification agent (MCSA) that was used in a cementing job. One of the study objectives was to investigate the effects of MCSAs on both physical and chemical properties of the mud cake, understanding the microstructure of the interfacial-transition zone (ITZ) between the cement and mud cake. The C-S-H generated at the cement-formation interface improved the microstructure of the cement mud cake interface enhancing durability and mechanical properties of the cement mud cake system. Ladva et al., (2004), Ladva et al., (2005) and Bybee (2005) also worked on cement to formation bonding and the existing interfacial transition zone. They tested shear bond strength between cement and sandstone in the presence of oil and water based muds. They found out that the presence of mud cake drastically reduces the cement-to-sandstone bond strength from 0.8 MPa (no mudcake) to 10^{-3} MPa (WBM), even more so to 10^{-5} MPa (OBM). They also documented that since oil based mud does not react with the cement, the shear bond strength for the OBM cake is weaker than for the WBM cake. Two conclusions were made. First, altering the filter cake chemically (pretreatment) will affect the interfacial bond strength thus changing the position of the shear-failure plane. Second, the failure

plane of cement placed against a mud filter cake is within the mud cake. Therefore, this has the potential to create gas flow pathways at the filter-cake-formation interface.

2.4 Cement Integrity Evaluation Logs

One of the objectives of a primary cement job is to provide complete zonal isolation between producing zones up to the surface over an extended period, to minimize completion, workover, and production costs. It is often a challenge to get a full evaluation of cement integrity downhole since many types of cased-hole wireline logs depend on good bonding between cement-to-rock and cement-to-casing. Additionally, erratic tool response is caused by poor bonding, therefore, making interpretation very difficult.

There are different logging methods discussed in the literature for evaluating cement job. Temperature logs have often been used for detecting cement top in addition to their applications to detect channeling and leaks. The mechanism of temperature log is based on temperature increase in the well caused by exothermic cement-hydration reactions. In most cases, the peak temperature is obtained 4-12 hrs. after cement placement sometimes more than 24 hrs., therefore for best results survey should be run within the first 12 to 24 hrs. (Suman and Ellis, 1977). Other techniques such as nuclear logs have been used to evaluate cement job. Using radioactive tracers can be instrumental in cement evaluation when a uniform concentration of radioactive materials is added to the cement slurry (Kline et al., 1986). Noise logs can help in detecting fluid flow behind casing. McKinley et al. (1973) discussed applications of noise logs for evaluating inter-zonal communication and their advantages to temperature surveys. For the most part, the bond formed across a permeable region is not the area of interest since the formation fluid can still migrate within such regions and channel at the interface with the overlying formation. The regions of interest are the impermeable zones, and it is imperative to deliver a tight seal across such zones (Parcevaux et al., 1984). Apart from using a well-designed cement slurry to prevent gas flow, detection logging devices such as noise log can be an alternative tool used to confirm flow channels behind casing strings. For instance, fluid movement from one sand zone to another sand zone creates turbulence, and this turbulence creates a sound field where its intensity is greater than the ambient noise level in the wellbore within the tubing. The logging sonde transmits the sound. The sound is further decomposed into frequencies that correspond to the type of flow (McKinley et al., 1979).

Martinez and McDonal (1980) concluded their study by developing effective logging-surveillance devices. Parcevaux et al. (1984) described laboratory methods for measuring cement physical properties including, shear and hydraulic bonds, permeability, and shrinkage under controlled pressure and temperature. They investigated these physical properties in relation to zonal isolation, examined their

individual contributions to bonding effectiveness and compared them to the compressive strength and cement deformability. They evaluated multiple standard cement slurry compositions, and compared them to bonding additive modified cement slurries. They observed that the bonding properties are directly correlated to the cement shrinkage and elasticity, with the lowest shrinkage and highest elasticity providing preeminent sealing. Cement with low shrinkage, high elasticity, and good mud removal property provided successful isolations. In addition, the study found that the compressive strength has no influence on the bonding properties of the cement.

Amongst many of evaluation logs, acoustic logging is the most widely used and an efficient method for cement job evaluation. The response of these tools is attributed to acoustic properties of casing, cement and formation. Since acoustic properties of rocks are known and constant through operation, it is possible to evaluate cement quality by monitoring changes in its acoustic properties with time. In many circumstances, details of well geometry, formation characteristics and cement job are required to analyze the acoustic logs. Additionally, it is vital to have details of logging-fluid properties since it will impact acoustic impedance. Furthermore, rigorous quality control is required for these logs, otherwise their results cannot be reliable (Nelson and Guillot, 2006). Additionally, cement formulation and design will impact its acoustic properties. Cement systems with low density and low solid-volume fraction have lower acoustic impedance that can change after several days (Jutten et al., 1989). In some cases, improvement in log response has been observed using time-lapse logs because of changes in acoustic impedance.

Cement bond log (CBL) is one of the most commonly used logs for cement evaluation since the 1960s. They are typically used to determine the integrity of a cement job by indicating the presence of a bond between the cement and production casing. Some of the earlier field and experimental results of CBLs were published in 1960s (Grosmanin et al., 1961; Anderson and Walker, 1961). An acoustic bond tool or sonic logging tool is used to measure the cement bond amplitude. The tool transmits acoustic signals through its transmitter, and registers received transmitted signals via the receiver. Typically, there are four paths (media) through which a signal can be transmitted. The first path is through the casing, since sound travels fastest in the steel, this signal arrives first. Cement and mud propagated signals are received last. The acoustic bond log measures amplitude, travel time, and variable density logs. Cement contacting the casing tends to attenuate the amplitude signal energy as it propagates through the steel casing, and this attenuation is directly proportional to the area of cement contacting the casing (Crain, 2015). The more cement bonding is around the casing, the greater the attenuation and vice versa. In an ideal CBL, it is desirable to have a weak casing signal followed by a strong reservoir rock signal. This would display low amplitude values on the amplitude curve in the CBL. In the absence of cement around a casing, the free pipe generates high amplitude readings, indicating poor cement jobs at the marked areas.

CBLs are often associated with interpretation complexities such as those related to cement-sheath thickness, pipe eccentricity and bond to pipe and bond to formation. For instance, in a study conducted by Bade in 1963 using 250 CBL runs, the need for proper centralization and taking measurements in short time intervals were highlighted. Pardue et al. (1963) developed interpretation charts still in use for CBL logs. Carter and Evans (1964) presented experimental findings for the pipe-to-cement bond, highlighting importance of casing surface finishes and cement placement techniques. Some other studies geared towards improving CBL tool configuration and other operational conditions such as tool-design differences and their resulting effects (Brown et al., 1970; Fertl et al., 1974).

As of the mid 80s, Nayfeh et al. (1986) investigated effects of borehole fluids on CBLs using numerical and experimental approaches. The authors explained that the recorded bond log amplitudes are affected by wellbore conditions such as wellbore fluid densities, hydrostatic pressures, temperature, and wellbore-fluid types. These variations can easily mask the true cement quality and the degree of isolation. To study wellbore fluid effects, they developed numerical and physical models that simulate wellbore geometry. They conducted measurements for a range of wellbore fluid types including calcium chloride (CaCl_2), zinc bromide (ZnBr_2), and calcium bromide (CaBr_2). In addition, simulations of CBLs showed that wellbore fluid effects can be separated from acoustic signal responses to a change in cement strength.

Variable density logs (VDL) are alternative evaluation tools that can be used for evaluating cement integrity. Since amplitude readings are not enough to tell the quality of cement jobs, VDLs fill the gap by revealing the quality of cement jobs (Cameron, 2013). The arrival times of received signals is a function of the distance travelled, the medium of path of propagation, and the density of the medium. The VDL is a combination of all arrivals recorded as a waveform. As shown in Figure 20, a good cement bond shows low amplitudes and inconsistent travel times. The VDL reads strong formation arrivals in the form of dark contours and no casing arrivals because of the high level of attenuation. In a bad cement job, high amplitude readings and straight travel times are observed. This is explained because of the absence of the cement around the casing to alter the travel times while the wave propagates. Overall, field practices propose low amplitude, high attenuation and high bond index as signs of a good cement job (Crain, 2015).

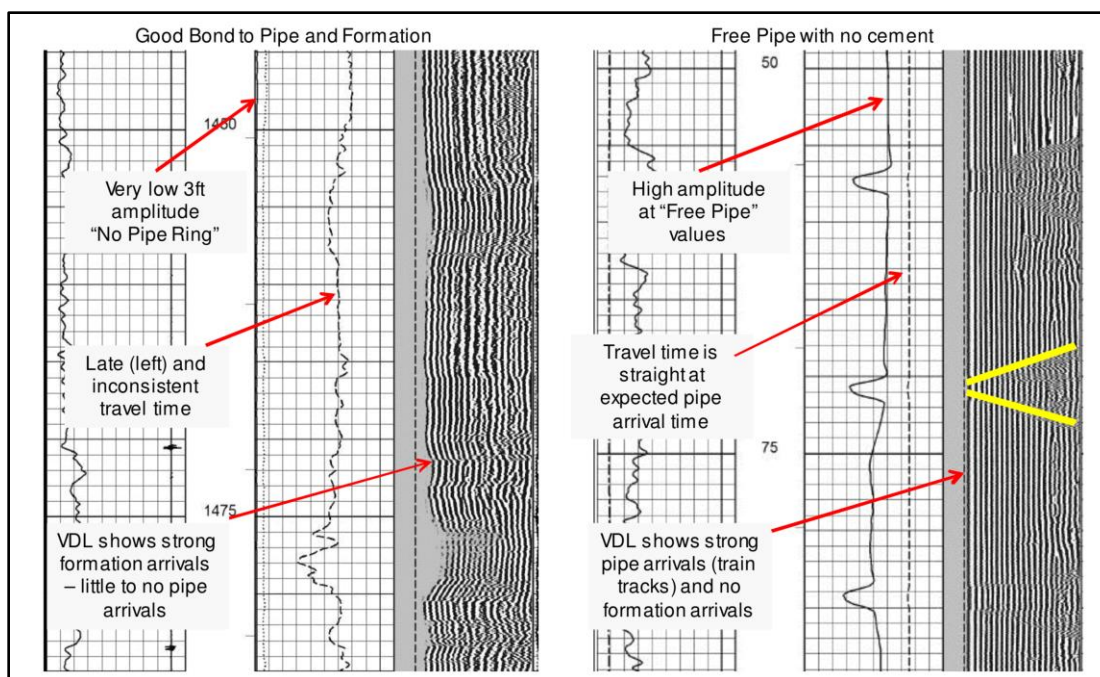

Figure 20. Combined cement integrity logs showing amplitude scale 1-100 mV (middle log), travel time scale 650-150 μ sec (middle log), and VDL 200-1200 μ sec (right log) (from Cameron 2013).

Bybee, 2007 highlighted factors that affect the log quality including microannuli, logging tool centralization, fast formations, lightweight cement, and cement setting time. The presence of microannuli can lead to the misinterpretation of the CBL/VDL. When these gaps are filled with water, they affect CBL/VDL and SBT (Segmented Bond Tool) more than USIT (Ultrasonic Imaging Tool). When filled with gas, the opposite is observed. Tool centralization is important for all tools including USIT, CBL and VDL. This is required for smooth and even tool movement. In the presence of fast formations CBL/VDL cannot be interpreted. Fast formations are defined as formations with high velocities and short transition time. Examples include, anhydrites, low-porosity limestone, and dolomites. In such formations, acoustic signals often reach the receiver ahead of the pipe signal, and this affects the CBL/VDL logs. Lightweight cement also affects log quality. Cement evaluation relies on a clear contrast (in acoustics signals received) between cement and liquids. Lightweight cement produces acoustic properties similar to regular cement slurry even after it has set, which makes it challenging to differentiate between the two. The cement set time is one of the parameters that influence log qualities. If the bond log is run prior to the setting of the cement, the results would indicate the presence of poor cementing, and leading to unnecessary cement squeeze operations and more operational costs.

Other studies have shown limitations of using acoustic evaluation techniques to investigate cement integrity for some lightweight and specialized cement additives. New techniques such as ultrasonic imaging helps with these limitations. Morris et al. (2007) developed a new ultrasonic imaging tool that

combines the pulse-echo technique with the flexural wave concept. The flexural wave concept provides time-based echoes arising from propagation along the casing and reflections at the cement-formation interface. The processed signals yield unprecedented imaging of the cement sheath, borehole geometry, casing position in the borehole, and an estimation of the velocity of the sound in the cement. This new method showed better vertical and radial resolution, providing an enhanced resolution of the contrast between the cement and displaced mud. It improved the interpretation of the zonal isolation even in light weight cements. In a field study, they compared both sonic tools and the new ultrasonic tool in different cementing materials, drilling fluids, and casing sizes. They recorded enhanced cement evaluation for all cement types using the ultrasonic imaging tool.

Summary and review of different tools and techniques for evaluating cement integrity indicates that they cannot be fully relied on to determine full integrity conditions downhole. Industry relies heavily on well logs such as Cement Bond Log (CBL) and Variable Density Log (VDL) to verify cement integrity. The current tools suffer from interpretation errors, as well as borehole conditions where microchannels can exist without being identified with these tests. Furthermore, challenges exist when running these tools on thick-walled casings, heavy mud systems, deviated wellbores and wellbore sizes. Several factors such as micro-annuli, eccentricity, casing dimension and coating, fast formations, lightweight cement, cement setting time, permeability of formation, viscosity and compressibility of saturated fluid affect the quality of data. Microannuli filled with liquid caused by temperature, mudcake deposits, pipe coatings, and constraint forces produce anomalous results in CBL/VDL data. Eccentric casing and erratic movement of tool also has a negative impact. Lightweight cement slurries cause very low contrast between liquid and hardened cement acoustic properties. In addition, cement setting time dictates the interpretation of log results. Several factors such as contamination, in-situ temperature and pressure, and material composition impact the setting time. Although, ultra-sonic cement evaluation tools are more sophisticated and effective in helping to determine bond quality in tight annuli, the verification of a cement barrier by interpretation of a cement evaluation log, is highly subjective, and based on inferences from downhole measurements.

2.5 Pressure Integrity Tests

Pressure integrity test (PIT) is conducted to evaluate wellbore integrity while drilling. After a successful cementing operation, pressure integrity tests are usually conducted before drilling the next wellbore section. It is generally believed that a successful pressure test of casing and liner is an indication of a good cement. However, one scenario might defy this hypothesis, for instance in the case of liner hangers, there is a lack of knowledge as to whether the presence of elastomer sealing materials can mask the integrity conditions of a cement column. Current formation integrity testing methods cannot determine

the integrity of each barrier individually, posing further risks in case of loss of well control events in other drilling intervals. Other open questions include how much cement can pass through the liner lap and whether it can be determined by pressure integrity tests.

Here, a review of different pressure integrity tests and pros and cons in each testing method are presented. Many factors such as wellbore condition, rock permeability, type of drilling fluid used in testing, compressibility, temperature and other operational conditions may affect pressure integrity test data explained in the following section.

2.5.1 Review of Pressure Integrity Tests

Formation integrity test (FIT) is one of the recognized industry pressure integrity test to evaluate cement and shoe integrity. In this test, pressure in the well is increased to a preset value based on evaluation of what formation pressures would be reached during safe drilling of the next borehole section (maximum mud weights that can be used to drill the next borehole section). In FIT, the modes of evaluation normally are based on the point at which a fracture begins, the point at which unstable fracture growth begins, or the closure pressure of the fracture when it ceases. Van Oort and Vargo (2008) stated that formation integrity tests are mostly inadequate because they are insensitive to slight pressure effects in hydraulic systems. Nygaard and Salehi (2011) discussed how pre-existing fractures complicate these tests and their interpretation. In addition, nonlinear thermal profiles, poor data capturing, and the use of highly compressible oil based or synthetic muds amidst others add to complexity to formation strength test interpretations. To improve both formation strength tests and their interpretations, use of downhole equivalent static density for the calculations of fracture gradient and casing shoe strength are recommended. Van Oort and Vargo (2008) suggested sole reliance on downhole pressure recorded by pressure while drilling data instead of using surface pressures recorded at the cement unit. Downhole pressure while drilling data eliminates mud gelation and temperature effects taking place during the formation integrity test. In addition, effects of fluid compressibility, gel strength, mud weight sag and thermal expansion need to be factored when using surface data. Ignoring these factors may lead to overestimating casing shoe strength. Furthermore, authors suggested continuous pumping during pressure tests at rates as low as possible. Recording downhole pressure and temperature can help in better prediction of shoe strength due to temperature dependency.

Alberty and McLean (2014) suggested that the early pressure buildup behavior in FIT is often overlooked, yet can provide insight in the integrity of a cement sheath. They presented a model for predicting early pressure buildup behavior, and discussed how this model can be used to predict pre-fracture behavior of the formation and improve the interpretation of the FIT. Their model incorporates the

effects of formation, cement and mud compressibility, casing expansion, channel volume, and permeability losses.

Leak-off tests (LOTs) and extended leak off tests (XLOTs) are alternatives to the formation integrity test (FIT). These tests are used for more accurate characterization of formation stresses. During an FIT, if the preset pressure does not cause the formation to fracture, the test is considered successful. Although this approach is safe, it tends to underestimate the fracture gradient resulting in costlier overbalance drilling. In the LOT, the pressure is increased till there is a leak-off of drilling fluid to the formation due to fracture initiation. If the leak off point in a LOT is equal to the fracture breakdown pressure, then the LOT does not perform appropriately in such formations. Hence XLOT is needed to understand the wellbore conditions (Nygaard and Salehi, 2011). In an XLOT, a significant fracture is created and preferably reopened in multiple cycles to accurately estimate the fracture gradient of the formation. Per Postler et al. (1997), an incorrect interpretation of a pressure integrity test may lead to unnecessary squeeze jobs, premature setting of casing, lost circulation, and other costly wellbore integrity issues. Some factors that affect pressure integrity test results include rock elasticity, fluid viscosity, fluid penetration, and formation permeability. The authors described that when a penetrating fluid such as oil based mud or water is used for pressure integrity tests, it tends to increase the pore pressure of the penetrated region. Pore pressure increase negatively impacts the compressive strength of the rock, and for the described scenario, the pressure integrity test would indicate a lower breakdown pressure for a penetrating fluid compared to a less-penetrating fluid. In addition, the first pressure integrity test for permeable formations initially shows non-linearity. But as the filter cake develops, this non-linearity decreases. To solve some of these issues, Postler et al. (1997) developed an accurate approach for interpreting pressure integrity test points, that would help drillers differentiate between cement problems and effects of the formation. They proposed guidelines that would help ensure a valid pressure integrity test. They concluded that repeated pressure integrity tests can be useful in differentiating between cement problems and formation-related effects.

Addis et al. (1998) compared LOT and XLOT data from the North-West Shelf of Australia and the Norwegian North Sea. They discovered that LOTs are characterized by a large scatter associated with the leak-off pressures, minimum stresses, and fracture gradients. However, this is not the case in XLOTs, where the minimum stress determined from XLOTs was consistent in both areas. They emphasized that though LOT fractures the formation, they do not deliver enough accurate data to properly estimate the minimum in-situ stress. However, some other approaches can be used in predicting the minimum in-situ stress from LOTs. The study concluded by stating that the stress data obtained from one lithology should not be extrapolated to other lithologies.

Most of the pressure testing such as leak off tests (LOT), formation integrity tests (FIT), and extended leak off test (XLOT) are severely impacted by wellbore conditions and therefore, test results are not completely reliable. In addition, an interpretation of these tests is very subjective. Debating issues exist among the industry in interpretations for different formations, or on wellbore trajectory effects. Furthermore, several factors can lead to improper LOT interpretation such as fluid expansion effect, wellbore temperature, and test fluid rheological properties in addition to other operational factors such as location of pressure gauges or inaccuracy in gauge readings. In a study conducted by Salehi and Nygaard (2012), it was shown that testing results can change by the existence of microfractures, initial crack on the wellbore, and natural fracture in the formation. Formation characteristic such as permeability is an important factor impacting test results. Pressure integrity tests for typical wells assumes an elastic wellbore and identifies the diversion point from the linear trends, as seen in Figure 21 (left). However, in shallow marine sediments, the leak off tests shown in Figure 21 (right) reveals an inherently non-linear trend, and analyses for the fracture breakdown point becomes a problem. In the study conducted by Zhou and Wojtanowicz (2002) for leak off tests on shallow marine sediments, it was shown that the typical LOT profile was completely different compared to deep wellbores.

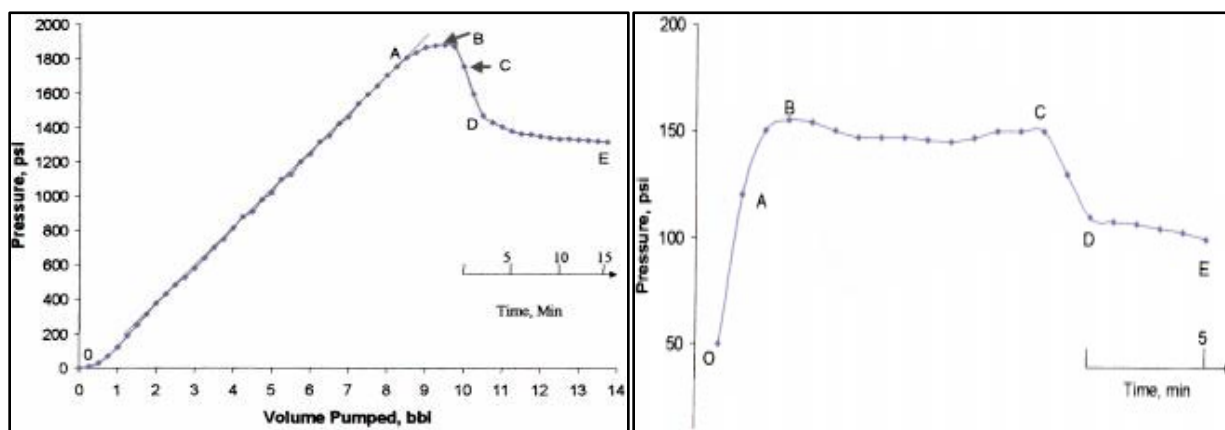

Figure 21. (left) typical leak-off test (right) LOT plot in shallow marine sediment (from Zhou and Wojtanowicz, 2002).

Zhou and Wojtanowicz (2002) presented mathematical models for pressure-volume behavior of annular crack (cement-rock parting) and formation fracture. These two failure modes control the abnormal LOT patterns in shallow marine sediments (SMS). They suggested that three kinds of annular cracks can occur: the first crack can occur between casing and cement, the second can occur within the cement itself, and the last crack can be found between the cement and the formation. Amongst these, the annular crack propagates along the weakest path (connection between cement and formation). The authors concluded that besides the hand-recorded pressure and volumes, continuous computer-recorded plots should be used to analyze LOT in shallow marine sediments. Mechanism of leak off is often hindered by discontinuities.

Additionally, rock fracturing can be identified and distinguished from both annular cement cracking and fluid loss, by comparing the maximum recorded LOT pressures with overburden pressure. Finally, a pressure plateau or discontinuity in the LOT pressure build-up section can be used to differentiate between annular cement cracking and fluid loss mechanisms.

Besides shallow marine sediments, the presence of gas can create nonlinearity behavior in LOTs, making data interpretation difficult. Altun et al. (2001) derived a mathematical model that analyses nonlinear LOT behavior to determine the fracture gradient of formations. Mud compression, casing expansion, and leak volumes are the major determining factors of any LOT with leak volumes being the cause of nonlinearity in LOT behavior. They observed a corresponding increase in nonlinearity with an increase in leak volume. Using this model, it was possible to observe the individual effects of these determining factors on the nonlinearity of the LOT, while postulating the existence of natural fractures from the analyses of the test behavior. Requiring excessive input data for accurate analysis is one drawback of such a model.

Raaen et al. (2001) discussed the pump-in or flow back test as an alternative approach to estimating in-situ stresses. In this test, fluid is flowed back at the surface with a constant flow rate or with a constant choke, and special interpretation schemes such as system stiffness during flow back can be used to estimate the in-situ stresses. System stiffness is the response of the well pressure due to fluid content changes resulting from leak-off to the formation or flow back at the surface. The study showed that the pump-in flow back test provides a robust and more reliable approach in estimating minimum in-situ stress. They also presented three field case studies for pump-in/flow back tests in offshore Norway. In the first case study, XLOT estimated the fracture closure pressure to be approximately 946 psi, while the fracture closure pressure was interpreted to be 609 psi from the flow back data. A similar error was witnessed in the subsequent two field data. These studies showed that in tight formations, standard XLOTs overestimate the minimum horizontal in-situ stress. The authors concluded that due to the overestimation from XLOT, flow back test should be the preferred casing shoe test if high quality in-situ stress data is desired. Furthermore, performing flow back test can save rig time compared to XLOT, since the 15-30 minutes shut-in time can be skipped after the first cycle.

Okland et al. (2002) reported field cases from Norne field offshore Norway with lost circulation incidents while drilling. The wells in this region had been successfully tested using the formation integrity tests. The XLOT test showed that the formation had a higher fracture initiation threshold, but lower minimum in-situ stress than predicted. Based on this understanding, they concluded that LOT and FIT gives erroneous pressures for diagnosing lost circulation problem, whereas XLOTs provide more reliable data for designs to minimize lost circulation.

Lavrov et al. (2016) used reservoir simulator and a hybrid explicit finite element approach to present a hydro-mechanically coupled numerical modelling of an XLOT. Their model recorded vital features of XLOT including slope change in pressure versus time curve during the flow back phase and the saw-tooth shape of the pressure versus injected volume curve. In a low permeable formation, they used this model to study the pressure behavior of the formation during the flow back phase, and investigated the effect of an already existing fracture on the results. Their results revealed that XLOTs are sensitive to the orientation of pre-fractures in the formation. “The fracture initiation pressure and the formation breakdown pressure increase steadily with decreasing angle between the fracture and the minimum in-situ stress.” The authors stated that aside the orientation of the pre-existing fracture, the length of the pre-existing fracture as well as the rate of injection can affect XLOT results.

2.6 Summary

Successful casing and cementing programs are especially critical for the shallow or top hole sections of a well. It will be very challenging to control a well when broaching of wellbore fluids occur. The presence of gas in the formation is a key consideration for designing casing and cements. Gas migration is a complex phenomenon which poses several challenges in terms of loss of well control incidents. Several factors such as cement properties, design, cement hydration and other operational conditions such as mud removal and pumping impact gas migration. Decades of research on gas migration has provided the oil and gas industry with solutions ranging from using special additives in cement, improving operational procedures and improving cement mixture designs. However, no single solution still exists to fit all downhole cases.

Many of loss of well control incidents have occurred due to gas migration either through the cement column, faulty equipment, faulty casing, and failure in different well construction barriers. Loss of well control in shallow sections can be very dangerous especially when detected late or hindered by human factors. Some of the recent LOWCs in the UC OCS such as MP 295 incident in 2013 and Vermilion block 356 in 2014 are examples of shallow gas incidents. A recent report classifies different major causes of shallow zone kicks such as unexpected high well pressure, annular losses (swabbing), poor cement, and other unknown factors. Some important factors to focus on with respect to shallow zone drilling include awareness of shallow gas, cement waiting time, cement fluid loss and annulus pressure while waiting on cement.

Differed cement evaluation logs are used to evaluate cement integrity. The current tools suffer from interpretation errors, as well as borehole conditions. In addition to logs, wellbore pressure integrity tests are implemented for evaluating wellbore integrity. Current formation integrity testing methods

cannot determine integrity of each barrier individually, therefore overall wellbore integrity can be questionable. This may pose further risks if a loss of wellbore control occurs later in drilling other intervals. Other open questions include how much cement can pass through the liner lap and whether it can be determined with pressure integrity tests.

Abbreviations

ACN	–	Acrylonitrile
atm	–	atmosphere
Bc	–	Bearden units of consistency
BOP	–	Blow out preventer
BSEE	–	Bureau of Safety and Environmental Enforcement
BWOC	–	By weight of cement
BWOW	–	By weight of water
CBL	–	Cement bond log
CSR	–	Compression stress relaxation
ECD	–	Equivalent circulating density
EDS	–	Energy dispersive spectroscopy
ELES	–	Ethoxylated lauryl ether
ENP	–	Ethoxylated nonyl phenols
EPDM	–	Neoprene ethylene propylene diene monomer
°F	–	Degree Fahrenheit
FEPM	–	Fluorocarbon/ Tetrafluoro ethylene/ Propylene rubber
FFKM	–	Perfluoroelastomer
FIT	–	Formation Integrity Test
FKM	–	Fluoroelastomer
ft ²	–	squared feet
GoM	–	Gulf of Mexico
HFA	–	Hydraulic fluid
HNBR	–	Hydrogenated Nitrile Butadiene Rubber
hrs.	–	hours
IIR	–	Butyl rubber
in	–	inch
ITZ	–	Interfacial-transition zone
lbm	–	pound mass
lbf	–	pound force
LFC	–	Lightweight foamed cement
LOT	–	Leak-off Test
LOWC	–	Loss of well control

MCSA	–	Mud cake solidification agent
min	–	minute
ml	–	milliliter
MMS	–	Mineral Management Service
mV	–	millivolts
MWD	–	Measurement while drilling
NAF	–	Non-aqueous fluid
NBR	–	Nitrile Butadiene Rubber
NCS	–	Norwegian Continental Shelf
NR	–	Natural rubber
OBM	–	Oil based mud
OCS	–	Outer Continental Shelf
PDM	–	Positive displacement motor
ppm	–	parts per million
PSA	–	Petroleum Safety Authority
PSD	–	Particle size distribution
psi	–	pounds per square inch
QC-FIT	–	Quality Control – Failure Incident Team
RGD	–	Rapid gas decompression
ROP	–	Rate of penetration
SAP	–	Super absorbent polymer
SBC	–	Styrenic block copolymer
SBR	–	Styrene butadiene rubber
SBT	–	Segmented bond tool
SEM	–	Scanning electron microscope
SMS	–	Shallow marine sediments
SWF	–	Shallow Water Flow
T _g	–	Glass transition temperature
TPO	–	Thermoplastic elastomer
USIT	–	Ultrasonic imaging tool
WOC	–	Wait on cement
XLOT	–	Extended Leak-off Test

Appendix

Table A1: Types of Elastomer, Description and Applications

No.	Name	Description / Application
1	NBR (Nitrile Butadiene Rubber) compound	<p>The properties of this copolymer are governed by the ratios of the two monomers acrylonitrile and butadiene. Nitrile rubber can be classified as three types based on the acrylonitrile (ACN) content (low, medium and high). The higher the CAN content, the higher will be the resistance to aromatic hydrocarbons. The lower the ACN content, the better will be the low temperature flexibility. The most commonly specified, and the best overall balance for most applications is, therefore, 'medium nitrile'.</p> <p>High Nitrile: >45% ACN content Medium Nitrile: 30 – 45% ACN content Low Nitrile: < 30% ACN content</p> <p>General characteristics of NBRs include excellent resistance to aliphatic hydrocarbon oils, fuels and greases, very low gas permeability, improved heat ageing and ozone resistance, improved tensile and abrasion strength, hardness, density and low compression set. Typical applications are as gaskets and seals, hoses and cable jacketing in hydraulic/pneumatic systems and oil/hydrocarbon based environments.</p> <p>250F</p>
2	HNBR (Hydrogen ated Nitrile Butadiene Rubber)	<p>HNBR elastomers are a saturated version of NBR, showing superior heat resistance. General properties include excellent wear resistance, high tensile strength, high hot-tear resistance, low compression set and very good ozone and weathering resistance. They also exhibit good resistance to many oil additives, hydrogen sulphide, high-energy radiation and amines present in crude oil. HNBRs fill the gap between NBRs and FKMs in many areas of application where resistance to heat and aggressive media are required simultaneously, and may therefore provide a lower cost alternative to FKM elastomers. Typical applications are in extreme environments such as oil-fields and under-bonnet automotive.</p> <p>300-320 F</p>
3	XNBR	250F
	Viton (FKM)	
4	A	Weight % Florine: 66 Tg (C): -17 Methanol Swell (%): 75-105
5	B	Weight % Florine: 68 Tg (C): -14 Methanol Swell (%): 35-45
6	F	Weight % Florine: 70 Tg (C): -8 Methanol Swell (%):5-10
7	High Performanc e: GLT	Weight % Florine: 64 Tg (C): -30 Methanol Swell (%): 75-105
8	High Performanc e: GBL	Weight % Florine: -- Tg (C): -15 Methanol Swell (%): 65
9	High Performanc e: GF	Weight % Florine: 70 Tg (C): -8 Methanol Swell (%):5-10
10	High Performanc e: GFLT	Weight % Florine: 66.5 Tg (C): -24 Methanol Swell (%):5-10

11	High Performance: ETP	Weight % Fluorine: 67 T _g (C): -11 Methanol Swell (%): Low
12	XNBR	
13	NBR/PVC Blend	
14	NR (Natural Rubber)	Natural rubber (tapped from the cultivated rubber tree) exhibits high tensile strength, abrasion resistance, resilience, tear strength and low hysteresis. These rubbers exhibit the best long range elasticity. The chemically similar IR (polyisoprene) has lower strength properties than the natural form but better low-temperature performance. Both rubbers are susceptible to degradation by weathering, and both show poor resistance to mineral and petroleum-based oils and fuels. Main applications apart from tires are for vibration mounts, springs and bearings
15	EPDM (Ethylene Propylene Rubber)	Ethylene-Propylene (EPDM) compounds are general purpose materials with superior resistance to water and steam, alcohols, glycol engine coolants and similar polar fluids. EPDMs are frequently specified for Skydrol® and other phosphate-ester hydraulic fluids. EPDM seals offer excellent economy (Figure 7). They are not recommended for petroleum based fluids and fuels. Individual EPDM compounds have service temperatures within the range from -65 to +300°F, including certain compounds formulated for higher temperatures. Parco's most popular EPDM compounds are 5601-70 (sulfur-cured) and 5778-70 (peroxide-cured).
16	High Temperature and Acid-Resistant Fluorocarbon Terpolymer Elastomer	used in the manufacture of expansion joints for use in coal-fired utilities and other high temperature industrial applications in which corrosive flue gases are present
17	FEPM (TFEP)	450F
18	FVMQ (Fluorosilicone)	FVMQ elastomers are modified silicone rubbers, which have many of the properties associated with silicone rubber but show great improvements in oil and fuel resistance. Typical properties include excellent resistance to ozone, oxygen, weathering and non-adhesive characteristics. They have a very wide service temperature range and low chemical reactivity. They do however have low tensile strength, poor tear and abrasion resistance and high gas permeability. Typical uses include sealing systems requiring wide temperature exposure and resistance to aerospace fuels and oils.
19	Nitrile Elastomer	Nitrile is the standard to which all the other elastomers are compared. Nitrile compounds are copolymers of acrylonitrile and butadiene. Acrylonitrile provides resistance to petroleum-based fluids such as oils and fuels, while butadiene contributes low temperature flexibility. Standard nitrile is also known as Buna N rubber. Because they are versatile and inexpensive, nitriles are the most popular industrial seal material. Nitrile compounds provide excellent service with gasoline, crude oil, power steering fluid, hexane, toluene, water, water-based hydraulic fluids, and dilute bases such as sodium hydroxide. Because nitriles contain unsaturated carbon-carbon bonds in the base polymer, they are not suitable for exposure to ozone, sunlight, and weathering. More than 50% of sealing needs can be met using nitrile. Individual nitrile compounds have service temperatures within the range from -65 to +250°F, including certain compounds formulated for lower temperatures. Parco's most popular nitrile compound is 4200-70.
20	ACM (Acrylic Rubber)	ACM (Polyacrylic or Polyacrylate) These rubbers are usually copolymers of ethyl acrylate and a vinyl ether and are resistant to heat, hydrocarbon oils and in particular, oil additives, especially sulphurised types used for lubrication under extreme pressure conditions. ACM elastomers offer excellent heat resistance; they can typically be used at temperatures of 150°C (up to 175°C for limited periods). They provide high resistance to ozone, weathering and oxidation but are extremely susceptible to hydrolysis, hence their unsuitability for use in aqueous media. Compression set, and low temperature flexibility depends on the base polymer and compounding choice. ACM elastomers are used primarily where combined resistance to heat and

		oil is required, typical uses include O-rings, seals and gaskets mainly for the automotive industry, particularly under-bonnet applications.
21	VMQ/PV MQ (Silicone)	These elastomers, which include the phenyl substituted silicones are noted for their high and low temperature applications (phenyl silicones offer exceptionally low temperature flexibility). They have excellent resistance to ozone and weathering and good resistance to compression set at high temperatures. They do, however, have poor tensile strength, low tear and abrasion resistance and high gas permeability. Silicones have a low level of combustible components; even when exposed to flame, the elastomer is reduced to a nonconducting silica ash. Silicones also exhibit excellent compression set and high physiological inertness (tasteless, odorless and completely non-toxic). Silicones are also resistant to bacteria, fungi, a wide range of media including high energy radiation and excellent release properties (except to glass). Platinum-cured silicones offer enhanced levels of purity and low extractables, making them ideal for pharmaceutical, biomedical and food & drink applications.
22	Vamac® ethylene/ac rylic elastomer	
23	Aflas Elastomer (FEPM)	Aflas® is a trade name for tetrafluoroethylene propylene copolymer. Aflas® compounds have almost universal resistance to both acids and bases, steam, acid gases, crude oil and many types of corrosion inhibitors. Serviceability extends to 400°F for long-term exposure. With combined resistance to corrosion inhibitors and heat, Aflas® seals are able to resist the extremes of heat and pressure present in aggressive downhole oil well environments. Aflas® seals have very low rates of gas permeation and are highly resistant to explosive decompression, making them excellent choices for downhole packing elements. Aflas® compounds have service temperatures from -10 to +400°F. Parco's most popular Aflas® compound is 7117-80.
24	NBR-G202	Use when well fluids consist of petroleum oil (≤ 25 API), higher percentages of sand ($\leq 5\%$) and water cut. Average physical properties.
25	NBR-G206	Use when well fluids consist of petroleum oil (≤ 35 API) and lower percentages of sand cut (2-3%). High physical properties.
26	HNBR- G206	Use when well fluids consist of petroleum oil (≤ 30 API) along with higher temperatures. Excellent gas permeation and H2S resistance (3-
27	PERLAST	A third generation perfluoroelastomer developed to meet the increasing need for seals with outstanding mechanical properties combined with excellent chemical resistance. This high-performance material combines the chemical and thermal resistance of polytetrafluoroethylene (PTFE) with the elastomeric properties of fluorocarbon (FKM).
28	AEM (Acrylic/Et hylene Copolymer)	These elastomers are terpolymers of ethylene, methyl acrylate and a cure site monomer. AEM elastomers offer good resistance to heat ageing, weathering, aliphatic hydrocarbons and good low temperature performance. They show poor resistance to strong acids, hydrolyzing agents and some polar fluids. AEM applications are like those of ACM elastomers, but AEM has the advantage where low temperature flexibility is concerned. Applications typically include shaft seals, spark plug boots, CV joint bellows and ignition wire jackets.
29	AU / EU (Polyester and Polyether Urethane)	These elastomers generally show outstanding tensile strength, tear and abrasion resistance, and give excellent protection against oxygen and ozone (except in hot climates, due to greater risk of microbiological attack in AU types, and ultraviolet light in the case of EU types). EU elastomers have a better low temperature flexibility (-35°C typically) and both have excellent resistance to high-energy radiation. Polyurethane rubbers are used where high abrasion resistance and oil / solvent resistance are required together, e.g. hydraulic seals and gaskets, diaphragms, hoses and roller-skate and skateboard wheels. In all applications, consideration should be given to hydrolysis and limited heat resistance.
30	CR (Chloropre ne)	Chloroprene rubbers are essentially chlorinated polyisoprenes, which exhibit medium resistance to high molecular weight oils. Chloroprene rubbers contain chlorine in the polymer to reduce the reactivity to many oxidizing agents, as well as to oil and flame. CR elastomers also have good resistance to ozone cracking, heat ageing and chemical attack. Some of the important applications of CR elastomers include

		Vee-belts, coated fabrics, cable jackets, tire-sidewalls, seals and gaskets in contact with refrigerants, mild chemicals and atmospheric ozone.
31	CSM (Chlorosulphonyl polyethylene or Chlorosulphonated polyethylene)	CSM grades contain 24-43% chlorine content to provide excellent ozone and weather resistance, high resistance to many oxidizing and corrosive chemicals, good resistance to dry heat to 150°C, low flammability and gas permeability, and good resistance to hot water (when cured with lead oxide). The low temperature properties are generally limited, depending on the chlorine content of the CSM grade used, and the compression set is not very good. CSM elastomers are generally useful in electrical applications, weather resistant membranes, hoses and acid resistant tank linings.
32	ECO (Epichlorohydrin)	These halogenated linear aliphatic polyethers show excellent resistance to ozone and weathering and very good resistance to hydrocarbon oils bettered only by polysulphides, fluoroelastomers and high-acrylonitrile nitrile rubbers. They exhibit good mechanical properties but are susceptible to sour gas attack. They are unsuitable for use with ketones and esters, alcohols, phosphate ester hydraulic fluids, sour gas, water and steam, and generally not recommended for rubber to metal bonding (they are corrosive to metals). The main applications for ECO elastomers are centered on the automotive industry, for use as seals, gaskets, diaphragms, cable jackets, belting, plus low temperature Natural Gas diaphragms.
33	EPR/EPDM (Ethylene-Propylene)	These rubbers are mainly available in two structures – as the copolymer (EPR), or as the terpolymer (EPDM). The properties for both types of rubber are very similar with the polymers exhibiting outstanding resistance to weathering, ozone, water and steam. These rubbers have good chemical resistance and are particularly recommended for use with phosphate ester based hydraulic systems. They are typically used in the production of window and door seals, wire and cable insulations, waterproofing sheets and hoses. They are not suitable for use with mineral oils or petroleum based fluids. These rubbers can either be Sulphur or peroxide-cured, in general Sulphur-cured grades have superior mechanical properties and inferior high temperature properties and viceversa for peroxide cured grades.
34	FEP/PFA (Fluoroethylene-Propylene-Perfluoroalkoxy)	These chemically modified fluorocarbon copolymers (fluoropolymers) appear more like plastic than rubber, they are extremely resilient and show excellent chemical resistance. Mechanical properties are very good even at high temperatures. Non-stick characteristics are excellent and abrasion resistance can be classified as moderate. The effective continuous temperature range is from -100°C to +200/250°C for FEP/PFA respectively. Typical applications include door seals and sealing systems in diaphragm pumps, cryogenic plants, sealed filter units, corrosive fluid plants, relief and emergency valves and pneumatics. Fluoropolymers are often used to encapsulate other elastomers to produce composite seals.
35	FEPM or TFE/P (Tetrafluoroethylene/Propylene)	A copolymer of tetrafluoroethylene and propylene, FEPM is solely produced by the Asahi Glass Company, and sold under the name Aflas®. FEPM vulcanisates exhibit similar thermal stability to FKM elastomers, but better electrical resistance and a different chemical resistance profile. FEPM compounds can resist a wide range of chemical combinations such as sour gas and oil, acids and strong alkalis, ozone and weather, steam and water, all hydraulic and brake fluids, alcohols, amine corrosion inhibitors, water-based drilling and completion fluids, high pH completion fluids and high energy radiation. However, they are not compatible with aromatic hydrocarbons, chlorinated hydrocarbons (e.g. M.E.K. and acetone), organic acetates and organic refrigerants. FEPM elastomers are suitable for long-term service in air up to 225°C and for short periods up to 250°C, but are limited in low temperature applications. They are finding wide applications mainly in oil-field operations and chemical processing as O-rings, seals and gaskets, cable insulating and jacketing and hose liners.
36	FFKM/FFPM (Perfluoroelastomer)	FFKM exhibits outstanding high temperature properties and are the most chemically resistant elastomer available; effectively a rubber form of PTFE. They are superior to FKM elastomers, showing continuous dry-heat resistance to 260°C, with extended performance to 330°C for high temperature grades. They are extremely inert chemically and show excellent resistance to most chemicals that attack other elastomers. Other notable properties include excellent resistance to oil-well sour gases, high temperature steam, low out-gassing under vacuum and good long-term high temperature compression set resistance. Typical applications are sealing systems for oil refineries, pharmaceutical plant, aerospace, chemical plant and the semiconductor industry. See Page 11 for details of Perlast®, the FFKM Perfluoroelastomer material from PPE.
36	FKM/FPM (Fluoroelastomer or	This class of rubber is available as a copolymer, terpolymer or tetrapolymer; the type determines the fluorine content and thus, chemical resistance. FKM materials are either bisphenolcured or peroxide-cured for better resistance to wet environments. General properties include excellent

	Fluorocarbon)	resistance to heat, aliphatic and aromatic hydrocarbons, chlorinated solvents and petroleum fluids. Fluoroelastomers have a clear superiority in O-ring sealing force retention over most other oil-heat resistant rubbers except for perfluoroelastomers such as Perlast® (see page 11). FKM/FPMs do show poor resistance to ethers, ketones, esters, amines and hydraulic fluids based on phosphate esters. Special compounds are required to provide suitable resistance to hot water, steam and wet chlorine. Typical applications are for valve-stem seals, crankshaft seals, diesel engine cylinder O-ring seals, pinion seals, glow plug seals, ducting expansion joints and seals for the aerospace industry.
37	IIR (Butyl)	This copolymerised structure of isobutene and isoprene has an effective long-term temperature range of -50° to +120°C. The key properties for this rubber are very low gas permeability and water absorption with very good resistance to ozone, weathering and oxygen. All grades have very low elastic resilience and are suitable for use with many fluids except for mineral and petroleum based chemicals. Typical applications are tire inner tubes, vacuum seals and membranes, pharmaceutical enclosures and shock absorbers.
38	IR (Polyisoprene)	Synthetic version of natural rubber; its strengths and uses are similar, but its relative purity means that IR materials tend to crystallize less at low temperatures. Consequently, it has better performance at lower temperatures but, at normal temperatures, its performance is inferior to natural rubber.
39	PTFE (Polytetrafluoroethylene)	Polytetrafluoroethylene is not an elastomer but an extremely inert thermoplastic, unaffected by virtually all known solvents. It also exhibits this inert characteristic over a wide range of temperatures. Its hardness and lack of elasticity prevents its general use as an elastomeric sealing ring, but it is often used as a back-up ring. Typical applications are backing rings, bearings and non-stick requirements, or for use in composite seals when combined with elastomers
40	DuPont™ Vamac® ethylene acrylic elastomer	Properties – good heat resistance up to 175°C, low-temperature properties, good resistance to engine oil and ATF, good comp set.
41	Ethylene Methyl Acrylate copolymer with cure site monomer	Applications – almost entirely automotive
42	DuPont™ Kalrez® — FFKM Elastomer	Properties – highest-performing elastomer with excellent heat and chemical resistance. DuPont manufactures finished parts. Heat resistance up to 327°C. Very low volume swells in aggressive chemicals and plasmas. Long seal life for low operating costs. Applications – Chemical and hydrocarbon processing, semiconductor manufacturing, aerospace engines, FDA-compliant food, pharmaceuticals and beverages.

Ref: Eriks Seals and Plastics (2017)

References

- Adams, N. J., Kuhlman, L. G. 1990. Case History Analyses of Shallow Gas Blowouts. Presented at the IADC/SPE Drilling Conference, Houston, Texas, February 27 - March 2. IADC/SPE 19917. *Society of Petroleum Engineers*. <http://dx.doi.org/10.2118/19917-MS>
- Addis, M. A., Hanssen, T. H., Yassir, N., Willoughby, D. R., Enever, J. 1998. A Comparison of Leak-Off Test and Extended Leak-Off Test Data for Stress Estimation. *Society of Petroleum Engineers*. <http://dx.doi.org/10.2118/47235-MS>.
- Alberty, M. W., and McLean, M. R. 2014. The Use of Modeling to Enhance the Analysis of Formation-Pressure Integrity Tests. *Society of Petroleum Engineers*. <http://dx.doi.org/10.2118/167945-PA>.
- Alberta Energy and Utilities Board: Statistical Series 57, Field Surveillance April 1998/March 1999, Provincial Summeries.
- Al-Buraik, K., Al-Abdulqader, K., Bsaibes, R. 1998. Prevention of Shallow Gas Migration through Cement. *Society of Petroleum Engineers*. <https://doi.org/10.2118/47775-MS>.
- Altun, G., Langlinais, J., and Bourgoyne, A. T. 2001. Application of a New Model to Analyze Leak-Off Tests. *Society of Petroleum Engineers*. <http://dx.doi.org/10.2118/72061-PA>.
- Amanullah, M. 2002. Experimental Determination of Adhesive-Cohesive Bond Strength (ACBS) and Adhesion-Cohesion Modulus (ACM) of Mudcakes. *Society of Petroleum Engineers*. <http://dx.doi.org/10.2118/77198-MS>.
- Anderson, W. L., and Walker, T. 1961. Research Predicts Improved Cement Bond Evaluations With Acoustic Logs. *Society of Petroleum Engineers*. <http://dx.doi.org/10.2118/196-PA>.
- API Standard 65 – Part 2. 2010. Second Edition. Isolating Potential Flow Zones During Well Construction. December 2010.
- Badrak, R. P. 1994. Effects of New Generation Drilling Fluids on Drilling Equipment Elastomers. Presented at SPE/ASDC Drilling Conference, 15-18 February, Dallas, Texas. *Society of Petroleum Engineers*. SPE-27452-MS <http://dx.doi.org/10.2118/27452-MS>
- Bannister, C. E., Shuster, G. E., Wooldridge, L. A., Jones, M. J., and Brich, A. G. 1983. Critical Design Parameters to Prevent Invasion During Cementing Operations. *Society of Petroleum Engineers*. <https://www.onepetro.org/download/conference-paper/SPE-11982-MS?id=conference-paper%2FSPE-11982-MS>.
- Barret, P., Ménétrier, D., and Bertrandie, D. 1983. ‘Mechanism of C3S Dissolution and Problem of Congruency in the Very Initial Period and Later On’ in *Cement and Concrete Research* 13(5):728-738 · September 1983 with 16 Reads
- Beirute, R. M., Cheung, P. R. 1990. Method for Selection of Cement Recipes to Control Fluid Invasion after Cementing. *Society of Petroleum Engineers*. <https://doi.org/10.2118/19522-PA>.
- Bing, Z., Kaiji, Z., and Qiji, Y. 1995. Equations help calculate surge and swab pressures in inclined wells. *Oil and Gas Journal*, 93(38).

<https://www.researchgate.net/publication/236477247> Equations help calculate surge and swab pressures in inclined wells.

Bogaerts, M., De Bruijn, G. G., Khalilova, P. R., Moretti, F., and Voon, E. 2012. Identifying and Mitigating the Risks of Shallow Flow in Deepwater Cementing Operations. Society of Petroleum Engineers. <https://doi.org/10.2118/155733-MS>

Bois, A., Vu, M., Galidiolo G., Badalamenti, A. 2017. Use of Advanced Gas Migration Model to Optimize Zonal Isolation. AADE-17-NTCE-104. <http://www.aade.org/technical-papers/2017-national-technical-conference-papers/>.

Bosma, Martin Genrard Rene, Cornelissen, Erik Kerst, Cuijpers, Juul, Picchioni, Francesco, Rastogi, Sanjay. 2006. *System for sealing a space in a wellbore*. EP 1 649 136 B1. <https://data.epo.org/publicationserver/rest/v1.0/publicationdates/20061018/patents/EP1649136NWB1/document.pdf>

Bour, D. L. and Wilkinson, J. G. 1992. Combating Gas Migration in the Michigan Basin. *Society of Petroleum Engineers*. <https://doi.org/10.2118/19324-PA>.

Bourgoyne A. T., Rocha L., Bender C., Bourgoyne D. 1995. Analysis of Platform Vulnerability to Cratering Induced by a Shallow Gas Flow. *Petroleum Engineering Department. Louisiana State University*.

Brown, H. D., Grijalva, V. E., and Raymer, L. L. 1970. New Developments in Sonic Wave Train Display and Analysis in Cased Holes, *Transactions of the SPWLA 11th Annual Logging Symposium*, (May 3-6, 1970), paper F.

BSEE 2015a, Investigation into the January 30, 2014 Loss of Well Control Lease OCS-G 17921, Vermilion Block 356, Well A-007. OCS report BSEE 2015-01. U.S. Department of the Interior, Bureau of Safety and Environmental Enforcement.

BSEE 2015b, Investigation of Loss of Well Control and Fire South Timbalier Area Block 220, Well No. A-3, OCS-G 24980, July 2013. OCS report BSEE 2015-02. U.S. Department of the Interior, Bureau of Safety and Environmental Enforcement.

BSEE. Bureau of Safety and Environmental Enforcement. 2014. QC-FIT evaluation of fastener failures addendum. https://www.bsee.gov/sites/bsee_prod.opengov.ibmcloud.com/files/memos/public-engagement/qc-fit-bp-bolts-report-final.pdf.

Burkhardt, J.A., 1961. Wellbore pressure surges produced by pipe movement. *Journal of petroleum technology*, 13(06), pp.595-605.

Cameron I. 2013. SPE “Back to Basics” Bond Log Theory and Interpretation. *FMC technologies*. https://higherlogicdownload.s3.amazonaws.com/SPE/5fc0079d-67a5-4dd9-a56f-190534ef5d3d/UploadedImages/April16_BtoB.pdf.

Bybee, K. (2005, August 1). The Cement-to-Formation Interface in Zonal Isolation. Society of Petroleum Engineers. <http://dx.doi.org/10.1016/10.2118/0805-0041-JPT>.

Cannon, G. E. (1934). Changes in hydrostatic pressure during withdrawing of drillpipe from the hole. In Presented at spring meeting. Southwestern district Fort Worth. Texas. April 1934. (Vol. 1, p. 7).

- Carter, L. G., and Evans, G. W. 1964. A Study of Cement-Pipe Bonding. *Society of Petroleum Engineers*. <http://dx.doi.org/10.2118/764-PA>.
- Carter, L. G., Cook, C., Snelson, L. 1973. Cementing Research in Directional Gas Well Completions. *Society of Petroleum Engineers*. <https://doi.org/10.2118/4313-MS>.
- Carter, L. G., Waggoner, H. F., and George, C. 1966. Expanding Cements for Primary Cementing. *Society of Petroleum Engineers*. <http://dx.doi.org/10.2118/1235-PA>.
- Cerasi, P., Ladva, H. K., Bradbury, A. J., and Soga, K. 2001. Measurement of the Mechanical Properties of Filtercakes. *Society of Petroleum Engineers*. <http://dx.doi.org/10.2118/68948-MS>.
- Chen, X., Bartos, J., Salem, H., and Zonoz, R. 2016. Elastomers for High Pressure Low Temperature HPLT Sealing. Presented at Offshore Technology Conference held in Houston, USA, 2-5 May 2016. OTC-27227-MS. <http://dx.doi.org/10.4043/27227-MS>
- Cheung, P. R., and Beirute, R. M. 1985. Gas Flow in Cements. *Society of Petroleum Engineers*. <http://dx.doi.org/10.2118/11207-PA>.
- Cheung, P. R., and Myrick, B. D. 1983. Field Evaluation of an impermeable Cement System for Controlling Gas Migration. *Society of Petroleum Engineers*. <http://dx.doi.org/10.2118/11983-MS>.
- Christian, W. W., Chatterji, J., Ostroot, G. W. 1976. Gas Leakage in Primary Cementing – A Field Study and Laboratory Investigation. *Journal of Petroleum Technology*. V. 28, No. 11. 1361-1369.
- Cong C. B., Cui C. C., Meng X. Y. 2013. Degradation of hydrogenated nitrile-butadiene rubber in aqueous solutions of H₂S or HCl, Chem. Res. Chin. Univ. 29 (2013) 806-810. <http://dx.doi.org/10.1007/s40242-013-2401-7>
- Cook, C., Cunningham, W. C. 1977. Filtrate Control - A Key in Successful Cementing Practices. Society of Petroleum Engineers. <https://doi.org/10.2118/5898-PA>.
- Cooke, C. E., Kluck, M. P., Medrano, R. 1983. Field Measurements of Annular Pressure and Temperature during Primary Cementing. *Society of Petroleum Engineers*. <https://doi.org/10.2118/11206-PA>.
- Cowan, K. M., & Eoff, L. (1993, January 1). Surfactants: Additives To Improve the Performance Properties of Cements. Society of Petroleum Engineers. <http://dx.doi.org/10.2118/25181-MS>
- Crain E. R. 2015. Crain's Petrophysical Handbook. Cement Integrity Logs – Part 1- CBL/VDL. <https://www.spec2000.net/07-cementlog1.htm>.
- Crespo, F. E., Ahmed, R. M., Saasen, A., Enfis, M., and Amani, M. 2012. Surge-and-Swab Pressure Predictions for Yield-Power-Law Drilling Fluids. *Society of Petroleum Engineers*. <http://dx.doi.org/10.2118/138938-PA>.
- Crespo, F., and Ahmed, R., 2012. A simplified surge and swab pressure model for yield power law fluids. *Journal of Petroleum Science and Engineering*, Volume 101, January 2013, Pages 12-20, ISSN 0920-4105, <http://dx.doi.org/10.1016/j.petrol.2012.10.001>.
- Dajiang, K., Yuanhua, L., Huali, Z., Yufei, L., Lin, Z., Kuanhai, D. 2017. Experimental studies on CO₂ corrosion of rubber materials for packer under compressive stress in gas wells, (2017), doi:10.1016/j.engfailanal.2017.01

- Danenberger, E. P. 1993. Outer Continental Shelf Drilling Blowouts, 1971-1991. *Offshore Technology Conference*. <http://dx.doi.org/10.4043/7248-MS>.
- Davies, O. M., Arnold, J.C., Sulley, S. 1999. The mechanical properties of elastomers in high-pressure CO₂. *Journal of materials Science*, 34, 417-422. <http://dx.doi.org/10.1023/A:1004442614090>
- Davis, T. W., and McCrady, D. D. 2008. Using Swellable Packers to Provide Annular Isolation for Multistage Fracture Treatments. Society of Petroleum Engineers. doi:10.2118/115775-MS <http://dx.doi.org/10.2118/115775-MS>
- Dean, G. D., and Brennen, M. A. 1992. A Unique Laboratory Gas Flow Model Reveals Insight To Predict Gas Migration in Cement. *Society of Petroleum Engineers*. <http://dx.doi.org/10.2118/24049-MS>.
- DeBruijin, G.; Skeates, C. et al. 2008. High pressure, high temperature technologies, *Oil Review* 20 (03): 46-60. Elliott, J. 2014. Diffusion in Polymers, Course M6-Lecture 6. http://people.ds.cam.ac.uk/jae1001/cus/teaching/materials/M6_lecture_6.pdf
- Drecq, P., and Parcevaux, P. A. 1988. A Single Technique Solves Gas Migration Problems Across a Wide Range of Conditions. *Society of Petroleum Engineers*. <http://dx.doi.org/10.2118/17629-MS>.
- Drobny, J.G., 2014. Handbook of thermoplastic elastomers. Elsevier.
- Eaton, L. F. 1999. Drilling Through Deepwater Shallow Water Flow Zones at Ursa. *Society of Petroleum Engineers*. <https://doi.org/10.2118/52780-MS>.
- Element, D.J., and Brown, N. P. 1996. Simulator improves control of kicks taken during tripping operations, *Oil and Gas Journal*, 1996. <http://www.ogj.com/articles/print/volume-94/issue-51/in-this-issue/drilling/simulator-improves-control-of-kicks-taken-during-tripping-operations.html>
- Encyclopaedia Britannica, 2009. Neoprene (CR) Chemical Compound. <https://www.britannica.com/science/neoprene>. Published July 20, 1998. Article revised and updated July 22, 2009. (Accessed June 3, 2017).
- Eriks Seals and Plastics (2017), Eriks O-ring Technical Handbook
- Evans, H. P. 1984. La tecnica efectiva para cementacion primaria en pozos de gas. Cuarto Congreso Latinoamericano de Perforacion, Caracas, Venezuela (October 1-5, 1984)
- Faul, R., Reddy, B. R., Griffith, J., Fitzgerald, R., and Waugh, B. 2000. Next-Generation Cementing Systems to Control Shallow Water Flow. *Offshore Technology Conference*. <https://doi.org/10.4043/11977-MS>
- Fernández, C., and Castaño, P. 2016. Compatibility Behavior of Elastomers for PCP Applications. *NACEI international*. NACE-2016-7106. <https://www.onepetro.org/conference-paper/NACE-2016-7106>
- Fertl, W. H., Pilkington, P. E., and Scott, J. B. 1974. A Look at Cement Bond Logs. *Society of Petroleum Engineers*. <http://dx.doi.org/10.2118/4512-PA>.
- Fontenot, J. E., and Clark, R. K. (1974, October 1). An Improved Method for Calculating Swab and Surge Pressures and Circulating Pressures in a Drilling Well. *Society of Petroleum Engineers*. <http://dx.doi.org/10.2118/4521-PA>.

- Garcia, J. A., and Clark, C. R. 1976. An Investigation of Annular Gas Flow Following Cementing Operations. *Society of Petroleum Engineers*. <http://dx.doi.org/10.2118/5701-MS>.
- Garcia, J. A., Clark, C. R. 1976. An Investigation of Annular Gas Flow Following Cementing Operations. *Society of Petroleum Engineers*. <https://doi.org/10.2118/5701-MS>.
- Gauffinet-Garrault, S. 2012. The rheology of cement during setting, Woodhead Publishing Limited, 2012.
- Gavioli, P., Vicario, R. 2012. The Evolution of the Role of Openhole Packers in Advanced Horizontal Completions: From Novel Technology to a Critical Key to Success. *Society of Petroleum Engineers*. <http://dx.doi.org/10.2118/132846-PA>
- Grosmaning, M. Kokesh, P. P., and Majani, P. 1961. A Sonic Method for Analyzing the Quality of Cementation of Borehole Casings. *Journal of Petroleum Technology* (February 1961) 13, No. 2, 165-71. <http://dx.doi.org/10.2118/1512-G-PA>.
- Guidroz, B. C., Barton, S. P., and Hussain, M. 2011, January 1. Can You Protect Your Motor Without Sacrificing Performance? *Society of Petroleum Engineers*. SPE-146575-MS. <http://dx.doi.org/10.2118/146575-MS>
- Hao H., Gu J., Huang J., Wang Z., Wang Q., Zou Y., Wang W. 2016. Comparative study on cementation of cement-mudcake interface with and without mud-cake-solidification-agents application in oil and gas wells, *Journal of Petroleum Science and Engineering*, Volume 147, November 2016, Pages 143-153, ISSN 0920-4105, <http://dx.doi.org/10.1016/j.petrol.2016.05.014>
- Harder, C., Carpenter, R., Wilson, W., Freeman, E., and Payne, H. 1992. Surfactant/Cement Blends Improve Plugging Operations in Oil-Base Muds. *Society of Petroleum Engineers*. <http://dx.doi.org/10.2118/23928-MS>
- Hartoni, A., Hobson, B., Huizenga, R., and Helmana, M. 2000. A Single Slurry System for Cementing Surface Casing in a Low Fracture Gradient Shallow Gas Area Off Shore Kalimantan. *Society of Petroleum Engineers*. <https://doi.org/10.2118/62747-MS>
- Hibbeler, J. C., DiLullo, G., and Thay, M. 1993. Cost-Effective Gas Control: A Case Study of Surfactant Cement. *Society of Petroleum Engineers*. <http://dx.doi.org/10.2118/25323-MS>.
[http://dx.doi.org/10.1016/0008-8846\(83\)90064-9](http://dx.doi.org/10.1016/0008-8846(83)90064-9).
- Izon, D., Danenberger, E., and Mayes, M. 2007. Absence of fatalities in blowouts encouraging in MMS study of OCS incidents 1992-2006. *Drilling contractor*, pp. 84-90, July/August 2007
- James Walker, 2012. Elastomeric Seals and Components for the Oil and Gas Industry Issue 10.1
- Jin Hyun-Ho, Hong Chang-Kook, Cho Dong-Lyun, and Kaang Shin-Young; (2008) Effects of Temperature on Hardness of Rubber Materials with Different Curing System. *Elastomers and Composites* vol. 43 (4), 213-220.
- Jutten, J. J., Guillot, D., and Parcevaux, P. A. 1989. Relationship between Cement Slurry Composition, Mechanical Properties, and Cement-Bond-Log Output. *Society of Petroleum Engineers*. <http://dx.doi.org/10.2118/16652-PA>.

Kelessidis, V. C., Fraim, M., Fardis, M., Karakosta, E., Diamantopoulos, G., Arkoudeas, P., Elhardalo, S., Lagkaditi, L., Papavassiliou, G. 2014. Comprehensive Assessment of Additive and Class G Cement Properties Affecting Rheology, Fluid Loss, Setting Time and Long Term Characteristics of Elastic Cements. *Society of Petroleum Engineers*. <http://dx.doi.org/10.2118/167731-MS>

Klingender, R.C. 2008. Handbook of Specialty Elastomers, Taylor & Francis Group, Boca Raton, FL.

Killian Paul. 2014. Understanding TPEs- RTP Company. 9 March 2014. <https://www.rtpcompany.com/wp-content/uploads/2014/03/Understanding-TPEs.pdf>

Kline, W. E., Kocian, E. M., and Smith, W. E. 1986. Evaluation of Cementing Practices by Quantitative Radiotracer Measurements. *Society of Petroleum Engineers*. <http://dx.doi.org/10.2118/14778-MS>.

Kubena, E., Ross, K. C., Pugh, T., and Huycke, J. 1991. Performance Characteristics of Drilling Equipment Elastomers Evaluated in Various Drilling Fluids. *Society of Petroleum Engineers*. SPE-21960-MS. <http://dx.doi.org/10.2118/21960-MS>

Kucyn, P. V. et al. 1997. Prevention des manifestations du gaz entre le tubage et les parois du puits et de l'éruption incontrôlée au cours du forage. *Gazovaja Promyshlennost*. Translated from Russian.

Lavrov, A., Larsen, I. Bauer, A. 2016. Numerical Modelling of Extended Leak-Off Test with a Pre-Existing Fracture. *Rock Mech Rock Eng* <http://dx.doi.org/10.1007/s00603-015-0807-x>

Ladva, H. K. J., Craster, B., Jones, T. G. J., Goldsmith, G., & Scott, D. (2005, September 1). The Cement-to-Formation Interface in Zonal Isolation. *Society of Petroleum Engineers*. <http://dx.doi.org/10.2118/88016-PA>.

Ladva, H. K. J., Craster, B., Jones, T. G. J., Goldsmith, G., & Scott, D. (2004, January 1). The Cement-to-Formation Interface in Zonal Isolation. *Society of Petroleum Engineers*. <http://dx.doi.org/10.2118/88016-MS>

Levine, D. C., Thomas, E. W., Bezner, H. P., and Tolle, G. C. 1979. Annular Gas Flow after Cementing: A Look at Practical Solutions. *Society of Petroleum Engineers*. <http://dx.doi.org/10.2118/8255-MS>.

Martinez J., and McDonal J. M. 1980. Study of Cementing Practices Applied to the Shallow Casing in Offshore Wells. National Energy Technology Laboratory. <http://www.netl.doe.gov/kmd/CDs/Disk17/C%20-%20Drilling%20Completion%20Stimulation/DOE%20BETC%202273%201.pdf>

Matthew, S. M., and Copeland, J. C. 1986. Control of Annular Gas Flow in the Deep Anadarko Basin. *Society of Petroleum Engineers*. <http://dx.doi.org/10.2118/14980-MS>.

McKinley, R. M., Bower, F. M., and Rumble, R. C. 1973. The Structure and Interpretation of Noise from Flow behind Cemented Casing. *Society of Petroleum Engineers*. <http://dx.doi.org/10.2118/3999-PA>.

Mitchell, R. F. 1988. Dynamic Surge and Swab Pressure Predictions. *Society of Petroleum Engineers*, <http://dx.doi.org/10.2118/16156-PA>.

Mitchell, R. F. 2004. Surge Pressures in Low-Clearance Liners. *Society of Petroleum Engineers*. <http://dx.doi.org/10.2118/87181-MS>.

MMS Safety Alert. U.S. Department of the Interior Minerals Management Service, Gulf of Mexico OCS Region. Safety Alert No. 216. October 22 2003. <https://www.bsee.gov/sites/bsee.gov/files/safety-alerts/safety/safety-alert-no-216.pdf>

Morgan, G.; Clarke, P. et al. 2014. Challenges of temperature extremes for elastomers materials. Presented at High Performance Polymers for Oil and Gas 2014, Edinburgh, Scotland, 15-16 April.

Morris, C. W., Sabbagh, L., Wydrinski, R., Hupp, J. L., van Kuijk, R., and Froelich, B. 2007. Enhanced Ultrasonic Measurements for Cement and Casing Evaluation. *Society of Petroleum Engineers. AADE* <https://doi.org/10.2118/105648-MS> <http://www.aade.org/technical-papers/2007-national-technical-papers/>

Nayfeh, T. H., Wheelis, W. B., and Leslie, H. D. (1986, August 1). The Fluid-Compensated Cement Bond Log. *Society of Petroleum Engineers*. <http://dx.doi.org/10.2118/13044-PA>.

Nelson B. E., Guillot D. 2006. Well Cementing. Second Edition. Schlumberger, Sugar Land, Texas 77478.

NORSOK Standard D-010. 2014. Well integrity in drilling and well operations. (Rev. August 3, 2014) <http://www.standard.no/pagefiles/1315/d-010r3.pdf>.

Nygaard R., Salehi S., 2011. A Critical Review of Wellbore Strengthening: Physical Model and Field Deployment. *American Association of Drilling Engineers*. AADE-11-NTCE-24. <http://www.aade.org/app/download/6857744804/aade-11-ntce-24.pdf>.

O’Leary, J., Flores, J. C., Rubinstein, P., and Garrison, G. 2004. Cementing Deepwater, Low-Temperature Gulf of Mexico Formations Prone to Shallow Flows. *Society of Petroleum Engineers*. <https://doi.org/10.2118/87161-MS>

Okland, D., Gabrielsen, G. K., Gjerde, J., Koen, S., and Williams, E. L. 2002. The Importance of Extended Leak-Off Test Data for Combatting Lost Circulation. *Society of Petroleum Engineers*. <http://dx.doi.org/10.2118/78219-MS>.

Overney R. M., Buenviaje C., R. Luginbuhk and F. Dinelli. 2000. Glass and Structural Transitions Measured at Polymer Surfaces on the Nanoscale. *Journal of Thermal Analysis and Calorimetry*, Vol. 59 (2000) 205-225. <http://citeseerx.ist.psu.edu/viewdoc/download?doi=10.1.1.530.124&rep=rep1&type=pdf>

Parcevaux, P. A., and Sault, P. H. 1984. Cement Shrinkage and Elasticity: A New Approach for a Good Zonal Isolation. *Society of Petroleum Engineers*. <http://dx.doi.org/10.2118/13176-MS>.

Parcevaux, P. A., Sault, P. H. 1984. Cement Shrinkage and Elasticity: A New Approach for a Good Zonal Isolation. *Society of Petroleum Engineers*. <http://dx.doi.org/10.2118/13176-MS>.

Pardue, G. H., and Morris, R. L. 1963. Cement Bond Log-A Study of Cement and Casing Variables. *Society of Petroleum Engineers*. <http://dx.doi.org/10.2118/453-PA>.

Pervez T, Qamar SZ, van de Velden M. 2012. Comparison between Fresh and Exposed Swelling Elastomer *Journal of Elastomers and Plastics*, Vol. 44, No. 3, May 2012, p 237–250 <http://dx.doi.org/10.1177/0095244311420530>

Philip, Z., Sharma, M. M., and Chenevert, M. E. 1998. The Role of Taylor Vortices in the Transport of Drill Cuttings. *Society of Petroleum Engineers*. <http://dx.doi.org/10.2118/39504-MS>.

- Pinto H. V. P. Gustavo, Rocha Marcelo S. José, Martins L. André, Petrobras. 2012. New Methodology for Gas Migration Prediction after Oilwell Cementing. AADE-12-FTCE-40. Presented in Houston, Texas, April 10-11 2012.
- Postler, D. P. 1997. Pressure Integrity Test Interpretation. *Society of Petroleum Engineers*. <http://dx.doi.org/10.2118/37589-MS>.
- Prince, P. K. 1990. Current Drilling Practice and the Occurrence of Shallow Gas. Society of Underwater Technology. SUT-AUTOE-v25-003. <https://www.onepetro.org/conference-paper/SUT-AUTOE-v25-003>
- PSA. Petroleum Safety Authority Norway. 2011. Annual Report. http://www.nsd.uib.no/polsys/data/filer/aarsmeldinger/AE_2011_29603.pdf.
- Qamar SZ, Hiddabi SA, Pervez T, Marketz F. 2009. Mechanical Testing and Characterization of a Swelling Elastomer, *Journal of Elastomers and Plastics*, Vol. 41, No. 5, September 2009, p 415-431 <http://dx.doi.org/10.1177/0095244309105248>
- Qamar SZ, Pervez T, van de Velden M., Sanchez FJ. 2012. Design and Fabrication of Test Facility for Longevity Testing of Elastomer Seals. *AME 2012 International Mechanical Engineering Congress and Exposition in Houston, Texas, USA, 9-15 November 2012*. IMECE2012-93145. <http://dx.doi.org/10.1115/IMECE2012-93145>
- Raaen, A. M., and Brudy, M. 2001. Pump-in/Flowback Tests Reduce the Estimate of Horizontal in-Situ Stress Significantly. *Society of Petroleum Engineers*. <http://dx.doi.org/10.2118/71367-MS>.
- Rae, P. 1987. Cementing: Preventing Gas Migration during Setting. *Noroil* (March 1987) No. 3, 31.
- Rae, P., Wilkins, D., and Free, D. 1989. A New Approach to the Prediction of Gas Flow after Cementing. Society of Petroleum Engineers. <http://dx.doi.org/10.2118/18622-MS>.
- Ravi, K. M., Beirute, R. M., and Covington, R. L. 1992. Erodability of Partially Dehydrated Gelled Drilling Fluid and Filter Cake. Society of Petroleum Engineers. <http://dx.doi.org/10.2118/24571-MS>.
- Roylance David. 2000. Atomistic Basis of Elasticity. Published 27 January 2000. *Massachusetts Institute of Technology*. http://web.mit.edu/course/3/3.11/www/modules/elas_2.pdf
- Rudolf, R.L. and Suryanarayana, P.V.R. 1997. Kicks Caused by Tripping-In the Hole on Deep, High Temperature Wells. Presented at the SPE Asia Pacific Oil and Gas Conference, Kuala Lumpur, Malaysia, 14 - 18 April. SPE 38055.
- Rupak K. Khandka. 2007. *Leakage behind Casing*. Norwegian University of Science and Technology, Trondheim, Norway. (June 11, 2007).
- Sabins, F. L., and Sutton, D. L. 1986. The Relationship of Thickening Time, Gel Strength, and Compressive Strength of Oilwell Cements. Society of Petroleum Engineers. *Society of Petroleum Engineers*. <http://dx.doi.org/doi:10.2118/11205-PA>.
- Sabins, F. L., Tinsley, J. M., and Sutton, D. L. (1982, December 1). Transition Time of Cement Slurries between the Fluid and Set States. Society of Petroleum Engineers. <http://dx.doi.org/10.2118/9285-PA>.
- Salehi, S. 2013. Modelling Near Wellbore Leakage Pathways in Shale Gas Wells: Investigating Short and Long Terms Wellbore Integrity. Presented at US EPA Technical Workshop on Well

Construction/Operation and Subsurface Modelling, April 16-17, US EPA Research Triangle Park, North Carolina

Salehi, S., and Nygaard, R. 2012. Numerical Modeling of Induced Fracture Propagation: A Novel Approach for Lost Circulation Materials (LCM) Design in Borehole Strengthening Applications of Deep Offshore Drilling. *Society of Petroleum Engineers*. <https://doi.org/10.2118/135155-MS>

Sanchez, R. A., Azar, J. J., Bassal, A. A., and Martins, A. L. 1999. Effect of Drillpipe Rotation on Hole Cleaning During Directional-Well Drilling. SPE-56406-PA. *Society of Petroleum Engineers*. <http://dx.doi.org/10.2118/56406-PA>.

Santos, O.L.A., 1991. Important Aspects of Well Control for Horizontal Drilling Including Deepwater Situations. SPEIADC Paper 21993 presented at 1991 SPE/IADC Drilling Conference, Amsterdam, March.

Sauer, C. W. 1987. Mud Displacement during the Cementing Operation: A State of the Art. *Journal of Petroleum Technology* (September 1987) Vol. 39, No. 9, 1091 – 11011 (paper SPE 14197). <http://dx.doi.org/10.2118/14197-PA>.

Schweitzer P.A, 2000. Mechanical and Corrosion-Resistant properties of Plastics and Elastomers.

Schwind, B. E., Payne, M. L., Otten, G. K., and Pattillo, P. D. 2001. Development of Leak Resistance in Industry Standard OCTG Connections using Finite Element Analysis and Full Scale Testing. *Offshore Technology Conference*. <http://dx.doi.org/10.4043/13050-MS>.

Seidel, F. A., and Greene, T. G. 1985. Use of Expanding Cement Improves Bonding and Aids in Eliminating Annular Gas Migration in Hobbs Grayburg-San Andres Wells. *Society of Petroleum Engineers*. <http://dx.doi.org/10.2118/14434-MS>.

Severine, A. E. B. and Grolier, J.P. E. 2005. Modification of the glass transition of polymers by high-pressure gas solubility, *Pure Appl. Chem.*, 77(7), 593-603. <http://dx.doi.org/10.1351/pac200577030593>

Shiflet Ned, Dion O. Michael, Flores P. David. 2005. A practical Solution to Control Gas Migration. AADE-05-NTCE-71. Presented in Wyndam Greenspoint, Houston, Texas, April 5-7, 2005. <http://www.aade.org/technical-papers/2005national-technical-papers/>.

Stone, W. H., and Christian, W. W. 1974. “The Inability of Unset Cement to Control Formation Pressure” paper SPE 4783 presented at the SPE Symposium of Formation Damage Control, New Orleans, Louisiana, USA (February 7-8, 1974). <http://dx.doi.org/10.2118/4783-MS>.

Suman, G. O., and Ellis, R. C. 1977. World Oil’s Cementing oil and gas well: including casing handling procedures. Houston, Texas, USA, Gulf Publishing Company (1977). <http://trove.nla.gov.au/work/21687563?q&versionId=26049805>.

Sutton, D. L., and Ravi, K. M. 1991. Low-Rate Pipe Movement during Cement Gelation to Control Gas Migration and Improve Cement Bond. *Society of Petroleum Engineers*. <http://dx.doi.org/10.2118/22776-MS>.

Sutton, D. L., Sabins, F. L., and Paul, R. 1984. New Evaluation for Annular Gas-Flow Potential. *Oil Gas Journal* (December 17 1984) No. 51, 109-112.

- Talabani, S., Hareland, G., and Islam, M. R. 1997. Gas Migration Eliminated Through Correct Cement Design Including Elastomers. *Society of Petroleum Engineers*. <http://dx.doi.org/10.2118/39279-MS>
- Tanaka, N. 2007. *World Energy Outlook 2007, China and India Insights* Chapter 1. International Energy Agency.
- Tang, M., Xiong, J., He, S., 2014. A new model for computing surge/swab pressure in horizontal wells and analysis of influencing factors, *Journal of Natural Gas Science and Engineering*, Volume 19, July 2014, Pages 337-343, ISSN 1875-5100, <http://dx.doi.org/10.1016/j.jngse.2014.05.026>.
- Taylor, K. W. 1990. Measuring the Low Temperature Performance of Seals and Seal Materials. Presented at a meeting of Energy Rubber Group, Spring Technical Session, Dallas, Texas, 17 May.
- Technology Assessment and Research Study Number 195: “Analysis of Platform Vulnerability to Cratering Induced by a Shallow Gas Flow.”
- Technology Assessment and Research Study Number 27: “Study of Cementing Practices Applied to the Shallow Casing in Offshore Wells.”
- Teodoriu C., Asamba P. 2015. Experimental study of salt content effect on class G cement properties with application to well integrity, *Journal of Natural Gas Science and Engineering*, Volume 24, May 2015, Pages 324-329, ISSN 1875-5100. <http://dx.doi.org/10.1016/j.jngse.2015.03.039>.
- Tinsley, J. M., Miller, E. C., Sabins, F. L., and Sutton, D. L. (1980, August 1). Study of Factors Causing Annular Gas Flow Following Primary Cementing. Society of Petroleum Engineers. <http://dx.doi.org/10.2118/8257-PA>.
- Tripathy, B. and Smith, K. 1998. The Myth about Low Temperature Performance of Fluoroelastomers in Oil Seal Applications *SAE Technical Paper 980850*, 1998, <http://dx.doi.org/10.4271/980850>
- Tuckner, P. F. 2005. Considerations and comparison for compression set Vs. Compression stress relaxation (CSR). Presented at Fall 168th Technical meeting, Pittsburg, PA, ACS rubber division, 1-3 Nov.
- Tynan Carroll. 2016. Successful selection of oil and gas seals, *World Pumps*, Volume 2016, Issue 9, September 2016, Pages 28-30, ISSN 0262-1762, [http://dx.doi.org/10.1016/S0262-1762\(16\)30235-8](http://dx.doi.org/10.1016/S0262-1762(16)30235-8)
- Van Oort, E., and Vargo, R. F. (2008, September 1). Improving Formation-Strength Tests and Their Interpretation. Society of Petroleum Engineers. <http://dx.doi.org/10.2118/105193-PA>
- Visakh P.M., Sabu Thomas, Arup K. Chandra, Aji. P. Mathew. 2013. *Advances in Elastomers I, Blends and Interpenetrating Networks*. Volume 11. Springer-Verlag.
- Wagner, R. R., Halal, A. S., and Goodman, M. A. 1993. Surge Field Tests Highlight Dynamic Fluid Response. *Society of Petroleum Engineers*. <http://dx.doi.org/10.2118/25771-MS>.
- Walker James. 2011. Elastomer Engineering Guide. 10 November 2011. https://www.jameswalker.biz/de/pdf_docs/148-elastomer-engineering-guide
- Wang Chengwen, Chen Xin, Wang Ruihe. 2016. Do chlorides qualify as accelerators for the cement of deepwater oil wells at low temperature? *Construction and Building Materials*. Volume 133, 15 February 2017, Pages 482-494, ISSN 0950-0618. <http://dx.doi.org/10.1016/j.conbuildmat.2016.12.089>

- Wang Zhengjin, Chen Chao, Qihan Liu, Yucun Lou, Zhigang Suo. 2017. Extrusion, slide, and rupture of an elastomeric seal. *Journal of the Mechanics and Physics of Solids*, Volume 99, February 2017, Pages 289-303, ISSN 0022-5096, <http://dx.doi.org/10.1016/j.jmps.2016.12.007>.
- Wang, C., Wang, R., Li, H., Bu, Y., Zhou, W. 2011. Design and Performance Evaluation of a Unique Deepwater Cement Slurry. *Society of Petroleum Engineers*. <http://dx.doi.org/10.2118/130266-PA>
- Wang, X., Sadana, A. K., and Mathur, V. 2015. Water-Swellable Elastomers for Heavy Brine Environments. *Society of Petroleum Engineers*. SPE-174825-MS. <http://dx.doi.org/10.2118/174825-MS>
- Watters, L. T., and Sabins, F. L. 1980. Field Evaluation of Method to Control Gas Flow Following Cementing. *Society of Petroleum Engineers*. <http://dx.doi.org/10.2118/9287-MS>.
- Way, P. W., Howard, P., and Johnson, A. 2000. Jetting Clean-Up of Formation Damage Caused by the Drilling Process. *Society of Petroleum Engineers*. <http://dx.doi.org/10.2118/62799-MS>.
- Webster, W. W., Eikerts, J. V. 1979. Flow After Cementing: A Field and Laboratory Study. *Society of Petroleum Engineers*. <https://doi.org/10.2118/8259-MS>.
- Whitfill, D. L., Heathman, J., Faul, R. R., and Vargo, R. F. 2000. Fluids for Drilling and Cementing Shallow Water Flows. *Society of Petroleum Engineers*. <https://doi.org/10.2118/62957-MS>
- Wolski, A., Junqueira, S., Negrão, C., 2014. A steady-state approach for evaluation of surge and swab pressures in flows with free surface boundary conditions, *Journal of Petroleum Science and Engineering*, Volume 122, October 2014, Pages 208-215, ISSN 0920-4105, <http://dx.doi.org/10.1016/j.petrol.2014.07.011>.
- Zhang, J., Weissinger, E. A., Peethamparan, S., Scherer, G. W. 2010. Early hydration and setting of oil well cement. *Cement and Concrete Research*, Volume 40, Issue 7, July 2010, Pages 1023-1033, ISSN 0008-8846. <http://dx.doi.org/10.1016/j.cemconres.2010.03.014>.